

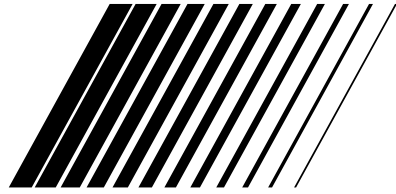

# JVC



## VIDEO CASSETTE RECORDER

# HR-J633U

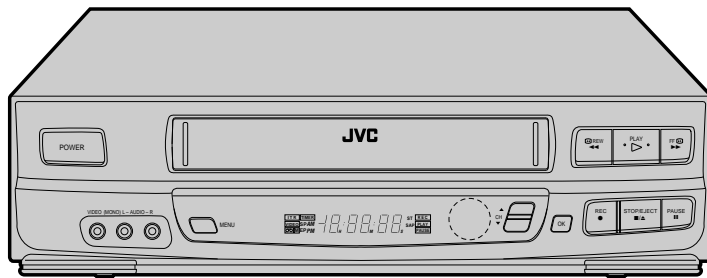

*Hi-Fi* **VHS**

## INSTRUCTIONS

**For Customer Use:**

Enter below the Serial No. which is located on the rear of cabinet. Retain this information for future reference.



Model No. **HR-J633U**

Serial No. \_\_\_\_\_

**Dear Customer,**

Thank you for purchasing the JVC VHS video cassette recorder. Before use, please read the safety information and precautions contained in the following pages to ensure safe use of your new VCR.

**CAUTIONS**

	<b>CAUTION</b> RISK OF ELECTRIC SHOCK DO NOT OPEN	
<p><b>CAUTION:</b> TO REDUCE THE RISK OF ELECTRIC SHOCK, DO NOT REMOVE COVER (OR BACK). NO USER-SERVICEABLE PARTS INSIDE. REFER SERVICING TO QUALIFIED SERVICE PERSONNEL.</p>		



The lightning flash with arrowhead symbol, within an equilateral triangle, is intended to alert the user to the presence of uninsulated "dangerous voltage" within the product's enclosure that may be of sufficient magnitude to constitute a risk of electric shock to persons.



The exclamation point within an equilateral triangle is intended to alert the user to the presence of important operating and maintenance (servicing) instructions in the literature accompanying the appliance.

**WARNING:**

**TO PREVENT FIRE OR SHOCK HAZARD, DO NOT EXPOSE THIS UNIT TO RAIN OR MOISTURE.**

**CAUTION:**

This video cassette recorder should be used with AC 120V~, 60Hz only.  
To prevent electric shocks and fire hazards, DO NOT use any other power source.

**CAUTION:**

TO PREVENT ELECTRIC SHOCK, MATCH WIDE BLADE OF PLUG TO WIDE SLOT, FULLY INSERT.

**ATTENTION:**

POUR ÉVITER LES CHOCS ÉLECTRIQUES, INTRODUIRE LA LÂME LA PLUS LARGE DE LA FICHE DANS LA BORNE CORRESPONDANTE DE LA PRISE ET POUSSER JUSQU'AU FOND.

**Note to CATV system installer:**

This reminder is provided to call the CATV system installer's attention to Article 820-40 of the NEC that provides guidelines for proper grounding and, in particular, specifies that the cable ground shall be connected to the grounding system of the building, as close to the point of cable entry as practical.

**CAUTION:**

Changes or modifications not approved by JVC could void user's authority to operate the equipment.

**Failure to heed the following precautions may result in damage to the VCR, remote control or video cassette.**

- DO NOT** place the VCR . . .
  - ... in an environment prone to extreme temperatures or humidity.
  - ... in direct sunlight.
  - ... in a dusty environment.
  - ... in an environment where strong magnetic fields are generated.
  - ... on a surface that is unstable or subject to vibration.
- DO NOT** block the VCR's ventilation openings.
- DO NOT** place heavy objects on the VCR or remote control.
- DO NOT** place anything which might spill on top of the VCR or remote control.
- AVOID** violent shocks to the VCR during transport.

**\*\*MOISTURE CONDENSATION**

Moisture in the air will condense on the VCR when you move it from a cold place to a warm place, or under extremely humid conditions—just as water droplets form on the surface of a glass filled with cold liquid. Moisture condensation on the head drum will cause damage to the tape. In conditions where condensation may occur, keep the VCR's power turned on for a few hours to let the moisture dry.

**\*\*ABOUT HEAD CLEANING**

Accumulation of dirt and other particles on the video heads may cause the playback picture to become blurred or interrupted. Be sure to contact your nearest JVC dealer if such troubles occur.



- Cassettes marked "VHS" (or "S-VHS") can be used with this video cassette recorder. However, only "VHS" recordings can be played back in this model.
- HQ VHS is compatible with existing VHS equipment.

## IMPORTANT PRODUCT SAFETY INSTRUCTIONS

Electrical energy can perform many useful functions. But improper use can result in potential electrical shock or fire hazards. This product has been engineered and manufactured to assure your personal safety. In order not to defeat the built-in safeguards, observe the following basic rules for its installation, use and servicing.

### ATTENTION:

Follow and obey all warnings and instructions marked on your product and its operating instructions. For your safety, please read all the safety and operating instructions before you operate this product and keep this booklet for future reference.

## INSTALLATION

### 1. Grounding or Polarization

(A) Your product may be equipped with a polarized alternating-current line plug (a plug having one blade wider than the other). This plug will fit into the power outlet only one way. This is a safety feature.

If you are unable to insert the plug fully into the outlet, try reversing the plug. If the plug should still fail to fit, contact your electrician to replace your obsolete outlet. Do not defeat the safety purpose of the polarized plug.

(B) Your product may be equipped with a 3-wire grounding-type plug, a plug having a third (grounding) pin. This plug will only fit into a grounding-type power outlet. This is a safety feature.

If you are unable to insert the plug into the outlet, contact your electrician to replace your obsolete outlet. Do not defeat the safety purpose of the grounding-type plug.

### 2. Power Sources

Operate your product only from the type of power source indicated on the marking label. If you are not sure of the type of power supply to your home, consult your product dealer or local power company. If your product is intended to operate from battery power, or other sources, refer to the operating instructions.

### 3. Overloading

Do not overload wall outlets, extension cords, or integral convenience receptacles as this can result in a risk of fire or electric shock.

### 4. Power Cord Protection

Power supply cords should be routed so that they are not likely to be walked on or pinched by items placed upon or against them, paying particular attention to cords at plugs, convenience receptacles, and the point where they exit from the product.

### 5. Ventilation

Slots and openings in the cabinet are provided for ventilation. To ensure reliable operation of the product and to protect it from overheating, these openings must not be blocked or covered.

- Do not block the openings by placing the product on a bed, sofa, rug or other similar surface.
- Do not place the product in a built-in installation such as a bookcase or rack unless proper ventilation is provided or the manufacturer's instructions have been adhered to.

### 6. Wall or Ceiling Mounting

The product should be mounted to a wall or ceiling only as recommended by the manufacturer.

## ANTENNA INSTALLATION INSTRUCTIONS

### 1. Outdoor Antenna Grounding

If an outside antenna or cable system is connected to the product, be sure the antenna or cable system is grounded so as to provide some protection against voltage surges and built-up static charges. Article 810 of the National Electrical Code, ANSI/NFPA 70, provides information with regard to proper grounding of the mast and supporting structure, grounding of the lead-in wire to an antenna discharge unit, size of grounding connectors, location of antenna discharge unit, connection to grounding electrodes, and requirements for the grounding electrode.

### 2. Lightning

For added protection for this product during a lightning storm, or when it is left unattended and unused for long periods of time, unplug it from the wall outlet and disconnect the antenna or cable system. This will prevent damage to the product due to lightning and power-line surges.

### 3. Power Lines

An outside antenna system should not be located in the vicinity of overhead power lines or other electric light or power circuits, or where it can fall into such power lines or circuits. When installing an outside antenna system, extreme care should be taken to keep from touching such power lines or circuits as contact with them might be fatal.

EXAMPLE OF ANTENNA GROUNDING AS PER NATIONAL ELECTRICAL CODE, ANSI/NFPA 70

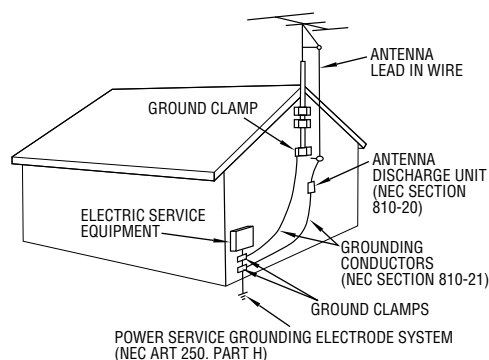

NEC - NATIONAL ELECTRICAL CODE



# 4

## USE

### 1. Accessories

To avoid personal injury:

- Do not place this product on an unstable cart, stand, tripod, bracket, or table. It may fall, causing serious injury to a child or adult, and serious damage to the product.
- Use only with a cart, stand, tripod, bracket, or table recommended by the manufacturer or sold with the product.
- Use a mounting accessory recommended by the manufacturer and follow the manufacturer's instructions for any mounting of the product.
- Do not try to roll a cart with small casters across thresholds or deep-pile carpets.

### 2. Product and Cart Combination

A product and cart combination should be moved with care. Quick stops, excessive force, and uneven surfaces may cause the product and cart combination to overturn.

**PORTABLE CART WARNING**  
(Symbol provided by RETAC)



### 3. Water and Moisture

Do not use this product near water—for example, near a bath tub, wash bowl, kitchen sink or laundry tub, in a wet basement, or near a swimming pool and the like.

### 4. Object and Liquid Entry

Never push objects of any kind into this product through openings as they may touch dangerous voltage points or short-out parts that could result in a fire or electric shock. Never spill liquid of any kind on the product.

### 5. Attachments

Do not use attachments not recommended by the manufacturer of this product as they may cause hazards.

### 6. Cleaning

Unplug this product from the wall outlet before cleaning. Do not use liquid cleaners or aerosol cleaners. Use a damp cloth for cleaning.

### 7. Heat

The product should be situated away from heat sources such as radiators, heat registers, stoves, or other products (including amplifiers) that produce heat.

## SERVICING

### 1. Servicing

If your product is not operating correctly or exhibits a marked change in performance and you are unable to restore normal operation by following the detailed procedure in its operating instructions, do not attempt to service it yourself as opening or removing covers may expose you to dangerous voltage or other hazards. Refer all servicing to qualified service personnel.

### 2. Damage Requiring Service

Unplug this product from the wall outlet and refer servicing to qualified service personnel under the following conditions:

- When the power supply cord or plug is damaged.
- If liquid has been spilled, or objects have fallen into the product.
- If the product has been exposed to rain or water.
- If the product does not operate normally by following the operating instructions. Adjust only those controls that are covered by the operating instructions as an improper adjustment of other controls may result in damage and will often require extensive work by a qualified technician to restore the product to its normal operation.
- If the product has been dropped or damaged in any way.
- When the product exhibits a distinct change in performance—this indicates a need for service.

### 3. Replacement Parts

When replacement parts are required, be sure the service technician has used replacement parts specified by the manufacturer or have the same characteristics as the original part. Unauthorized substitutions may result in fire, electric shock or other hazards.

### 4. Safety Check

Upon completion of any service or repairs to this product, ask the service technician to perform safety checks to determine that the product is in safe operating condition.

## HOW TO USE THIS INSTRUCTION MANUAL

- All major sections and subsections are listed in the Table Of Contents on page 5. Use this when searching for information on a specific procedure or feature.
- The Index on pages 43–45 lists frequently-used terms, and the number of the first page on which they are used or explained in the manual. This section also illustrates the controls and connections on the front and rear panel, the front display panel and the remote control.
- The  mark signals a reference to another page for instructions or related information.
- Operation buttons necessary for the various procedures are clearly indicated through the use of illustrations at the beginning of each major section.

## BEFORE YOU INSTALL YOUR NEW VCR . . .

. . . please read the sections/literature listed below.

- "Cautions" on page 2
- "Important Products Safety Instructions" on the previous pages



# CONTENTS

## **I** NSTALLING YOUR NEW VCR **6**

**Basic Connections ..... 6**

## **I** NITIAL SETTINGS **7**

**Clock ..... 7**

Automatic Clock Setting ..... 7

Preparation ..... 7

Language Select ..... 8

Clock Setting ..... 8

Auto ..... 8

Semi-Auto ..... 9

Manual ..... 10

**Tuner ..... 11**

Set Receivable Channels ..... 11

Add Or Delete A Channel ..... 13

## **S** IMPLE PLAYBACK AND RECORDING **14**

**Simple Playback ..... 14**

**Simple Recording ..... 15**

## **P** LAYBACK AND RECORDING FEATURES **16**

**Playback ..... 16**

Still Picture ..... 16

Slow, Reverse, Reverse Slow Or Fast-Motion

Picture ..... 16

Manual Tracking ..... 17

Select The Soundtrack ..... 18

Superimpose ..... 19

Skip Search ..... 20

Repeat Playback ..... 20

Index Search ..... 20

Instant ReView ..... 21

Counter Reset ..... 21

Counter Memory ..... 21

Tape Position Indicator ..... 22

Next-Function Memory ..... 22

AV COMPU LINK Playback ..... 22

**Active Video Calibration ..... 24**

Preparation ..... 24

Recording ..... 25

Playback ..... 26

**Recording ..... 27**

Record One Program While

Watching Another ..... 27

Display Elapsed Recording Time ..... 27

Stereo And SAP (Second Audio Program) ..... 28

To Record SAP Programs ..... 28

## **T** IMER RECORDING **29**

**Instant Timer Recording (ITR) ..... 29**

**On-Screen Timer Programming ..... 29**

Check And Cancel Programs ..... 31

Auto Timer ..... 32

## **E** DITING **33**

**Edit To Or From Another VCR ..... 33**

Control Two JVC VCRs ..... 33

**Edit From A Camcorder ..... 34**

**Assemble Editing ..... 36**

## **S** PECIAL FEATURES **37**

TV Multi-Brand Remote Control ..... 37

Cable Box Multi-Brand Remote Control ..... 38

Child Lock ..... 38

## **T** ROUBLESHOOTING **39**

**Power ..... 39**

**Tape Transport ..... 39**

**Playback ..... 39**

**Recording ..... 39**

**Timer Recording ..... 40**

**Other Problems ..... 40**

## **Q** UESTIONS AND ANSWERS **41**

**Playback ..... 41**

**Recording ..... 41**

**Timer Recording ..... 41**

## **S** PECIFICATIONS **42**

## **I** NDEX **43**

**List Of Terms ..... 43**

**Front View ..... 44**

**Rear View ..... 44**

**Front Display Panel ..... 45**

**Remote Control ..... 45**

## **F** OR SERVICING **46**

## **W** ARRANTY **47**



# 6

## INSTALLING YOUR NEW VCR

# Basic Connections

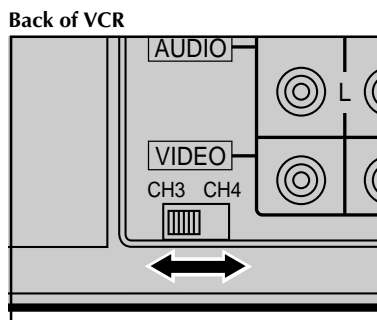
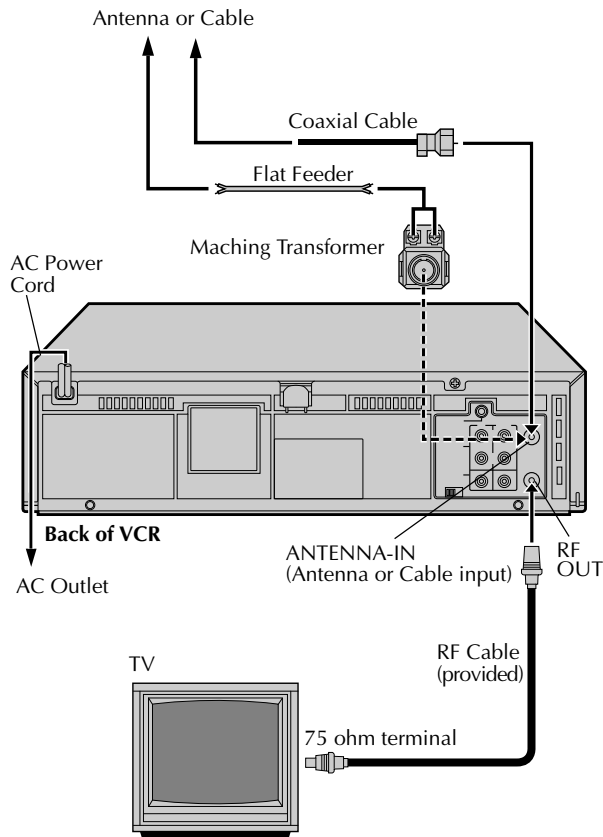

### 1 CHECK CONTENTS

Make sure the package contains all of the accessories listed in "SPECIFICATIONS" (☞ pg. 42).

### 2 SITUATE VCR

Place the VCR on a stable, horizontal surface.

### 3 CONNECT VCR TO TV

The connection method you use depends on the type of TV you have.

#### RF Connection

- To Connect To A TV With NO AV Input Terminals . . .
  - a- Disconnect the TV antenna from the TV.
  - b- Connect the TV antenna cable to the ANT IN jack on the rear of the VCR.
  - c- Connect the supplied RF cable between the RF OUT jack on the rear of the VCR and the TV's antenna terminal.

#### AV Connection

- To Connect To A TV With AV Input Terminals . . .
  - a- Connect the antenna, VCR and TV as shown in the illustration.
  - b- Connect an Audio/Video Cable (not supplied) between the AUDIO OUT and VIDEO OUT jacks on the rear of the VCR and the AV IN jacks on the TV.

### 4 CONNECT VCR TO POWER SOURCE

Connect the power plug to an AC outlet.

- The clock will automatically be set when the antenna is connected and when the AC is first connected to the VCR (☞ pg. 7).

### 5 FINAL PREPARATION FOR USE

Select the VCR channel (3 or 4) by setting the switch on the rear of the VCR as shown in the illustration.

Turn on the power to the TV. You are now able to perform simple playback (☞ pg. 14) and recording (☞ pg. 15). (If 'Auto' is displayed on the front display panel, the clock is being set automatically. Wait for the time to be displayed before powering on the VCR.)

### NOTES:

- The VCR channel is the channel on the TV which will display the audio and video signals from the VCR. The VCR's CH3-CH4 switch sets the VCR channel to CH3 or CH4.
- The CH3-CH4 switch is preset to the CH3 position. Set to CH4 if CH3 is used for broadcasting in your area.
- If your TV has no AV input terminals, set the channel on the TV to correspond to the CH3-CH4 switch on the back of the VCR.
- Even if your TV has AV input terminals, you must connect it to the VCR using an RF cable in order to record one show while watching another (☞ pg. 27).
- For full identification of the VCR's rear panel, refer to the Index (REAR VIEW ☞ pg. 44).

# Clock

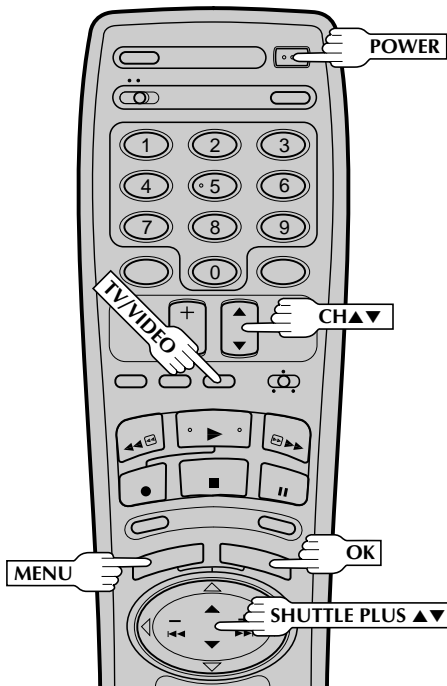
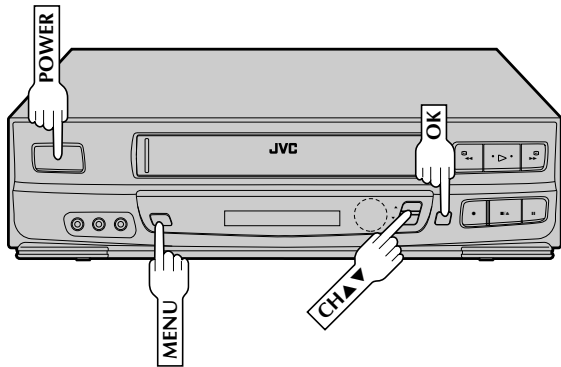

### ATTENTION CABLE BOX SUBSCRIBERS

- If you perform Auto or Semi-Auto clock setting procedures . . .
- Select the PBS channel on your cable box before plugging your VCR's power plug into the AC outlet. (If you have more than one PBS channel, you may have to select the PBS channel if Auto clock setting is not successful.)
  - The cable box must be set to the PBS channel at clock adjustment times, or the adjustment will not take place.
  - If you perform Auto clock setting successfully, D.S.T. will be set to "AUTO". In this case, at the D.S.T. adjustment time (pg. 9), your cable box must be set to the host PBS channel in your area or the adjustment will not take place. If the clock is not set correctly, change the D.S.T. setting to "ON" or "OFF" (see step 6 of Semi-Auto procedure, or step 3 Manual procedure).

## Automatic Clock Setting

The time and date can be set automatically from additional clock setting data that is transmitted by one of the regular TV broadcast channels. We call this TV channel the "Host Channel" and it is a PBS channel in your area. With the antenna cable connected, your VCR can automatically set the clock when the power plug is first connected to an AC outlet.

The auto clock function scans all the channels received by your VCR to find the clock setting data of the Host Channel.

*\*Don't turn the power on until the time (or "-- : --") appears on the front display panel.*

Before the clock is set, AUTO appears on the display.

NOT SET



SET



After setting, the current time appears (in hours and minutes).

The automatic clock setting function will normally set the clock correctly. However, if an incorrect time is displayed on the front display panel, you may be receiving the clock setting data of a PBS channel from an adjacent time zone, or an incorrect PBS channel from a cable TV system. In this case, perform the Semi-Auto (pg. 9) or Manual (pg. 10) clock setting procedure.

If "AUTO" remains in the display for more than 30 minutes, perform the Semi-Auto (pg. 9) or Manual (pg. 10) clock setting procedure. In the case of Semi-Auto, you have to set the Host Channel manually.

If "AUTO CLOCK SET" or "SEMI-AUTO CLOCK SET" is selected, the clock will be adjusted automatically by the Host PBS every hour on the hour (except for 11:00 PM, midnight, 1:00 AM and 2:00 AM) according to the incoming PBS channel clock setting data. (Automatic clock adjustments can only be received when the VCR's power is turned off.)

If "-- : --" appears on the display, your antenna cable may not be connected to the VCR, there may not be a Host PBS signal available in your area, or your cable box may not be set to the PBS channel. If everything is connected and set correctly, perform the manual clock setting procedure (pg. 10).

## Preparation

### 1 TURN ON THE VCR

Press **POWER**. If watching channel 3 or 4, press **TV/VIDEO** to select the VIDEO mode. VIDEO is displayed on the front display panel.

### 2 ACCESS ON-SCREEN MENU

Press **MENU** to bring up the Main Menu screen.

### 3 ACCESS CUSTOM SET SCREEN

At the Main Menu screen, place the arrow next to "CUSTOM SET" by pressing **CH▲▼** or **SHUTTLE PLUS ▲▼**, then press **OK**.



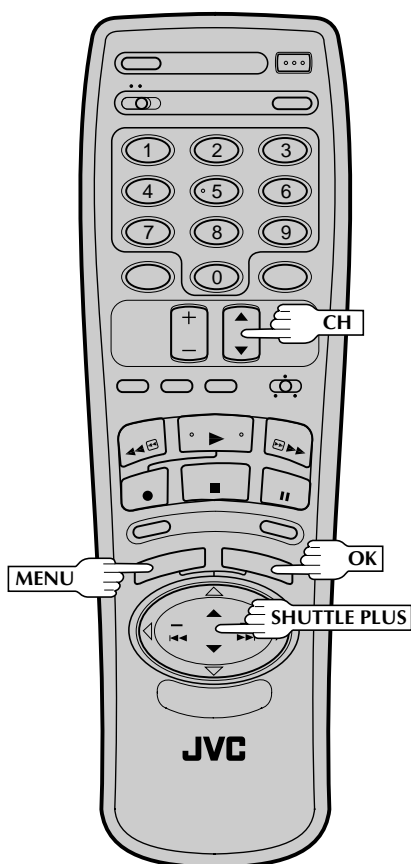
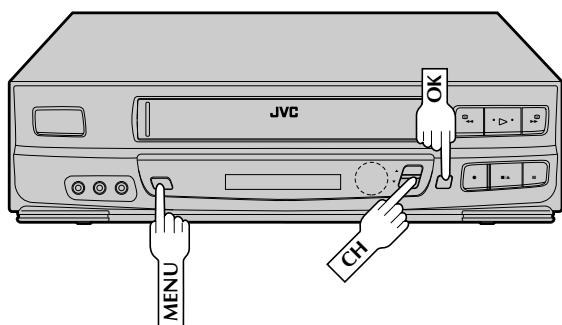

## Language Select

### 1 ACCESS LANGUAGE SELECT SCREEN

The messages are preset to appear in English. If you want to see them in Spanish or French, place the arrow next to "LANGUAGE SELECT" by pressing **CH▲▼** or **SHUTTLE PLUS▲▼**, then press **OK**.



### 2 SELECT LANGUAGE

At the Language Select screen, place the arrow next to the desired language by pressing **CH▲▼** or **SHUTTLE PLUS▲▼**, then press **MENU**. The Custom Set screen reappears.



## Clock Setting

This step must be performed before going on to Auto, Semi-Auto or Manual clock setting procedures (each starts from step 2). Auto need only be selected if Semi-Auto or Manual had previously been selected.

### 1 ACCESS MODE SELECT SCREEN

Place the arrow at the Custom Set screen next to "OVERRIDE AUTO CLOCK SET" by pressing **CH▲▼** or **SHUTTLE PLUS▲▼**, then press **OK**.



## Auto

### 2 SELECT MODE

At the Override Auto Clock Set screen, place the arrow next to "AUTO CLOCK SET" by pressing **CH▲▼** or **SHUTTLE PLUS▲▼**, then press **OK**.

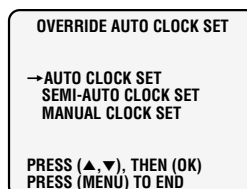

### 3 TURN OFF THE VCR

The Auto Clock Set screen appears. Read the message, press **MENU** to return to the normal screen, then turn off the VCR until you see the time displayed.





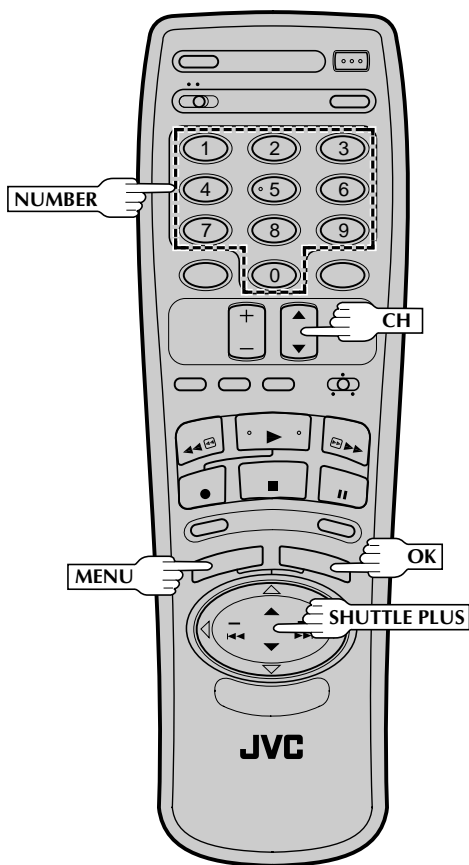
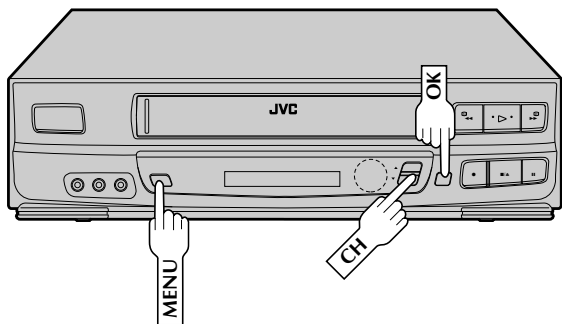

**\*\*AUTO DAYLIGHT SAVING TIME**

This function enables automatic adjustment of the VCR's clock at the start and end of Daylight Saving Time. With Auto DST activated, . . .  
 . . . on the first Sunday of April at 2:00 AM, the clock is adjusted to 3:00 AM.  
 . . . on the last Sunday of October at 2:00 AM, the clock is adjusted to 1:00 AM.

**Semi-Auto**

**2 SELECT MODE**

At the Override Auto Clock Set screen, place the arrow next to "SEMI-AUTO CLOCK SET" by pressing **CH▲▼** or **SHUTTLE PLUS ▲▼**, then press **OK**.

**3 ACCESS SELECT SCREENS**

At the Semi-Auto Clock Set screen, place the arrow next to the desired mode by pressing **CH▲▼** or **SHUTTLE PLUS ▲▼**, then press **OK**.

SEMI-AUTO CLOCK SET	
→	HOST CHANNEL SELECT
	TIME ZONE SELECT
	D.S.T. SELECT
PRESS (▲, ▼), THEN (OK)	
PRESS (MENU) TO END	

To select the Host Channel — step 4  
 To select the Time Zone — step 5  
 To select the D.S.T. mode — step 6

**4 SELECT HOST CHANNEL**

You can either select "AUTO", or enter a PBS channel number. For automatic channel selection, simply press **MENU**. To manually select the PBS channel, press the appropriate **NUMBER** key, **CH▲▼** or **SHUTTLE PLUS**

HOST CHANNEL SELECT	
	(CATV)
	CH AUTO
PRESS (▲, ▼) TO SELECT	
PRESS (MENU) TO END	

**▲▼** to cycle through the channel numbers (hold button down to speed through numbers) and stop when the desired number appears. Press **MENU** and the Semi-Auto Clock Set screen reappears.

**NOTE:**

*There are some PBS channels that do not transmit clock setting data.*

**5 SELECT TIME ZONE**

You can either select "AUTO", or select the correct zone. If you selected "AUTO" in step 4 and if you live near the boundary of an adjacent time zone, or receive cable TV channels, a PBS channel from a different time zone may become your host channel. Therefore, in this case make sure to manually select the correct time zone. Place the arrow next to your choice by pressing **CH▲▼** or **SHUTTLE PLUS ▲▼**, then press **MENU** to return to the Semi-Auto Clock Set screen.

TIME ZONE SELECT	
→	AUTO
	ATLANTIC
	EASTERN
	CENTRAL
	MOUNTAIN
	PACIFIC
	ALASKA
	HAWAII
PRESS (▲, ▼) TO SELECT	
PRESS (MENU) TO END	

CONTINUED ON NEXT PAGE.

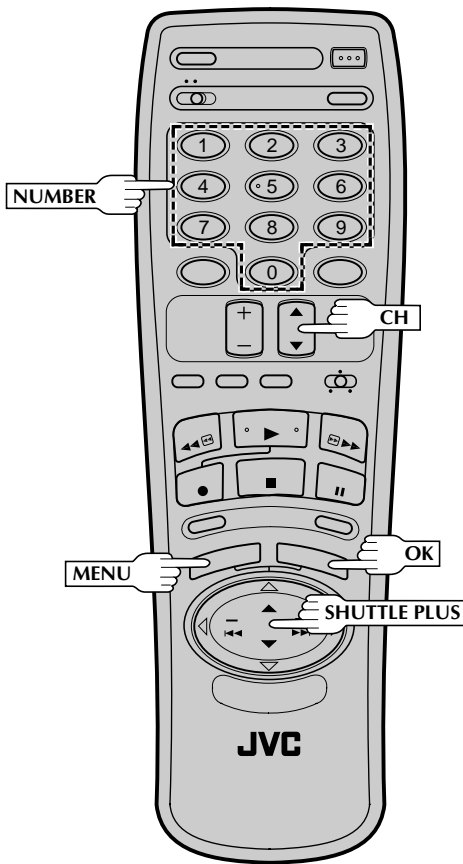
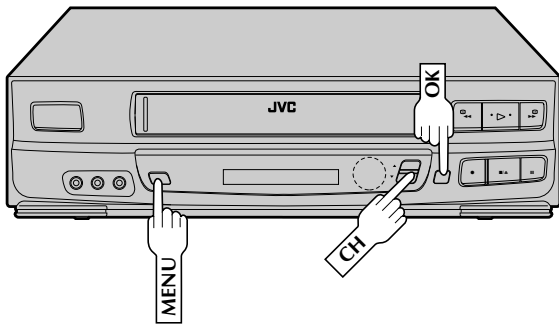

6

SELECT D.S.T. MODE

You have three choices:  
**a**–Select “AUTO” and the adjustment to your VCR’s clock will be made according to the incoming signal from the host channel.  
**b**–Select “ON” and the adjustment will be made based on the clock itself.  
**c**–Select “OFF” if Daylight Saving Time doesn’t apply to you.

D.S.T. SELECT	
→AUTO ON OFF	
PRESS (▲,▼) TO SELECT PRESS (MENU) TO END	

Place the arrow next to your choice by pressing **CH▲▼** or **SHUTTLE PLUS ▲▼**, then press **MENU** and the Semi-Auto Clock Set screen reappears.

IMPORTANT

After performing the Semi-Auto clock set procedure, make sure that the VCR is off before the next hour so that the clock can be set. (The clock is automatically adjusted on the hour except at 11:00 PM, midnight, 1:00 AM and 2:00 AM.)

Manual

2

SELECT MODE

At the Override Auto Clock Set screen, place the arrow next to “MANUAL CLOCK SET” by pressing **CH▲▼** or **SHUTTLE PLUS ▲▼**, then press **OK**.

3

SET DATE, TIME AND D.S.T.

The Manual Clock Set screen is displayed and the first setting that can be set begins flashing. Press the appropriate **NUMBER** keys to set the date and time (if only 1 digit, press “0” first). Press **CH▲▼** or **SHUTTLE PLUS**

MANUAL CLOCK SET	
DATE	1/ 1/96 MON
TIME	--:-- AM
D.S.T.	ON
PRESS NUMBER KEY(0-9) OR (▲,▼), THEN (OK) PRESS (MENU) TO END	

**▲▼** to set AM/PM and D.S.T. (Daylight Saving Time) to “ON” (automatic adjustment based on VCR’s clock) or “OFF” (if D.S.T. doesn’t apply to you). Press **OK** after AM/PM and D.S.T. settings. The next setting that can be set begins flashing. When you’re finished with this set-up procedure, press **MENU** to start the clock.

NOTE:

**CH▲▼** and **SHUTTLE PLUS ▲▼** can be used to perform all operations. (In this case, press **OK** after each setting.)

4

MAKE CORRECTIONS

To change any of the settings, press **OK** or **SHUTTLE PLUS** **◀◀ ▶▶** until the item you want to change blinks, then set as in step 3.

# Tuner

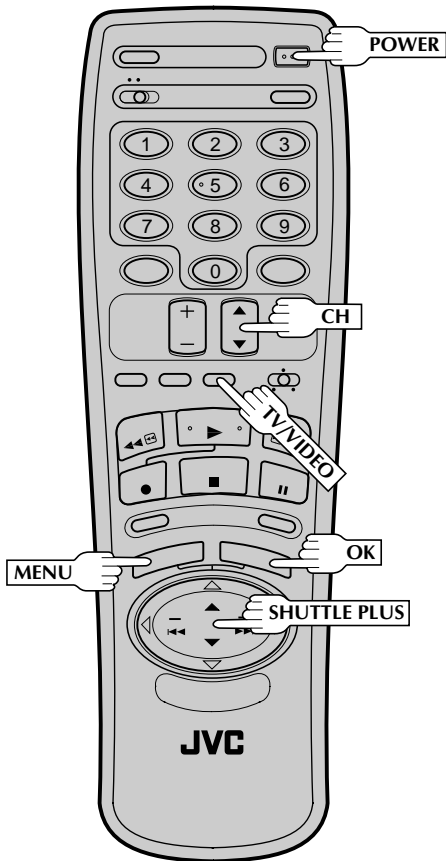
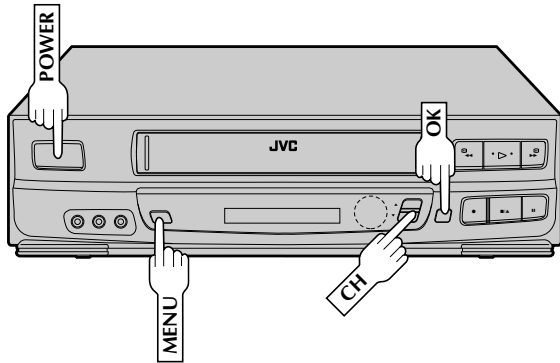

## Set Receivable Channels

1

### TURN ON THE VCR

Press **POWER**. If watching on channel 3 or 4, press **TV/VIDEO** to select the VIDEO mode. VIDEO is displayed on the front display panel.

2

### ACCESS MAIN MENU SCREEN

Press **MENU**.

3

### ACCESS TUNER SET SCREEN

Place the arrow next to "TUNER SET" by pressing **CH▲▼** or **SHUTTLE PLUS ▲▼**, then press **OK**.

4

### ACCESS BAND SCREEN

Place the arrow next to "BAND" by pressing **CH▲▼** or **SHUTTLE PLUS ▲▼**, then press **OK**.



5

### SET FREQUENCY BAND

If you receive your TV channels from an external antenna, select "TV". If you receive your TV channels from a cable TV system, select "CATV".

Place the arrow next to your choice by pressing **CH▲▼** or **SHUTTLE PLUS ▲▼**, then press **MENU** to return to the Tuner Set screen.

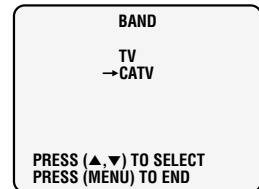

CONTINUED ON NEXT PAGE.

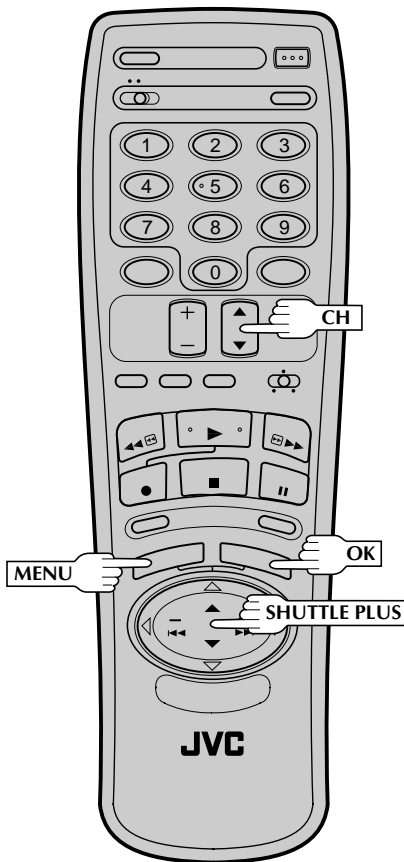
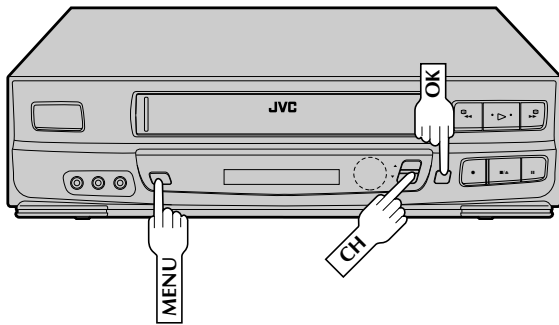

6

## PERFORM AUTO CHANNEL SET

Place the arrow next to "AUTO CHANNEL SET" by pressing **CH▲▼** or **SHUTTLE PLUS ▲▼**, then press **OK**. Receivable channels in your area are automatically assigned to the **CH▲▼** buttons, and non-receivable channels are skipped.

AUTO CHANNEL SET

(TV)  
CH 2 ADD  
SCANNING ...

PRESS (MENU) TO END

### NOTES:

- At the end of Auto Channel Set, "SCAN COMPLETED" appears on screen.
- If the scan was unsuccessful, "SCAN COMPLETED-NO SIGNAL" appears on screen. Check the band setting and connections and start again.

## RETURN TO NORMAL SCREEN

7

Press **MENU** as many times as necessary.

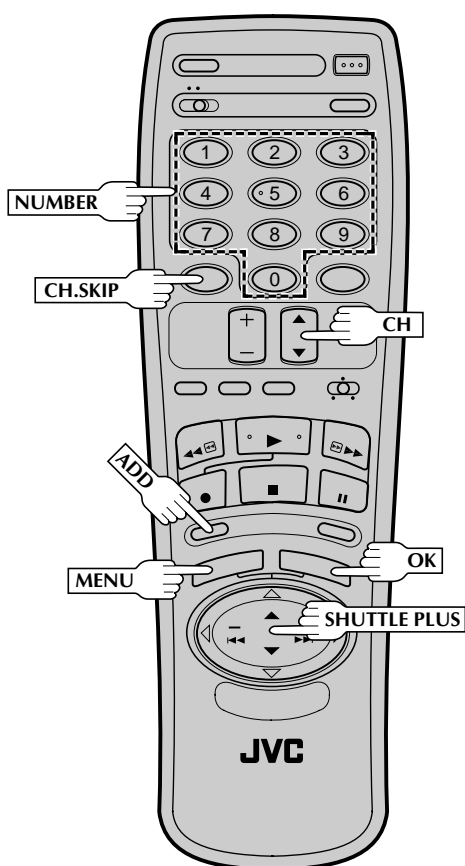
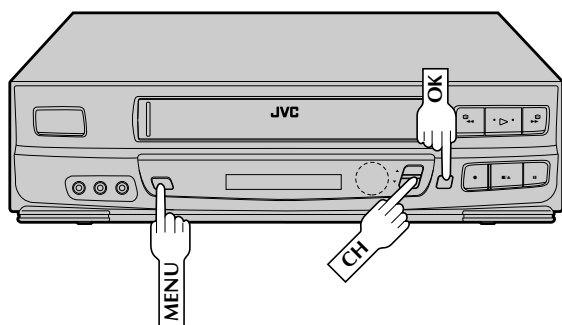

## Add Or Delete A Channel

1

### ACCESS TUNER SET SCREEN

Access by performing steps 2 and 3 of the Tuner procedure.

- To add a channel, go to step 2.
- To delete a channel, skip to step 4.

2

### ACCESS AFC SCREEN

Place the arrow next to "AFC" by pressing **CH▲▼** or **SHUTTLE PLUS ▲▼**, then press **OK**.

3

### MAKE SELECTION

Place the arrow next to "SPCL" by pressing **CH▲▼** or **SHUTTLE PLUS ▲▼**, then press **MENU** to return to the Tuner Set screen.

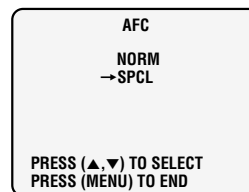

4

### ACCESS MANUAL CHANNEL SET SCREEN

Place the arrow next to "MANUAL CHANNEL SET" by pressing **CH▲▼** or **SHUTTLE PLUS ▲▼**, then press **OK**.

5

### STORE DESIRED CHANNEL

Input the channel number using the **NUMBER** keys or by pressing **CH▲▼** or **SHUTTLE PLUS ▲▼**, then press **ADD** to add or **CH.SKIP** to delete. Repeat for each channel you want to store or skip.

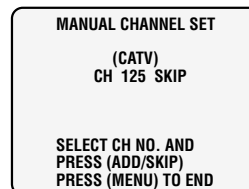

6

### RETURN TO NORMAL SCREEN

Press **MENU** as many times as necessary.

# Simple Playback

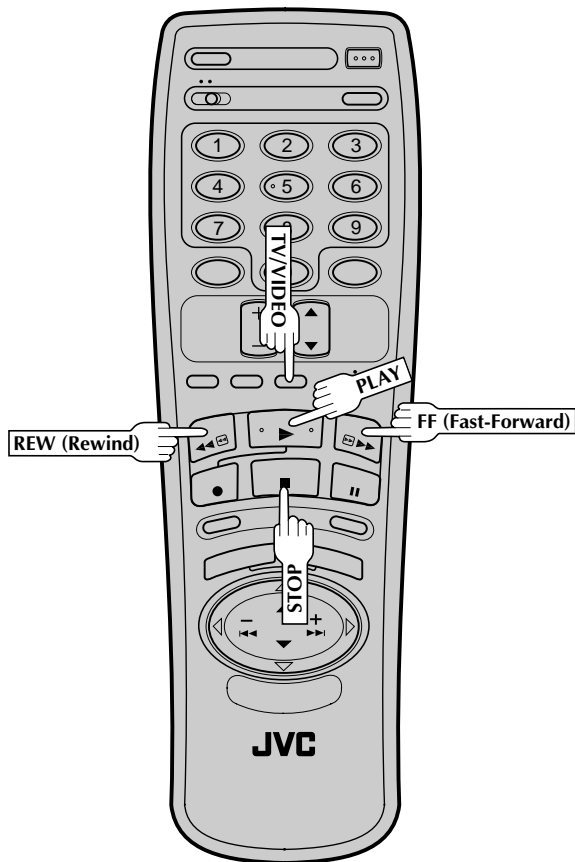
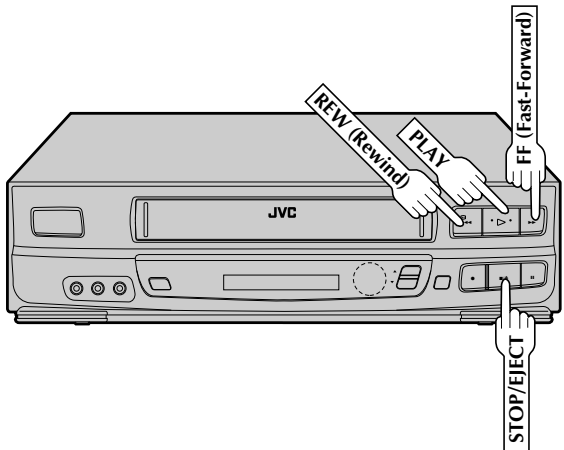

## 1 LOAD A CASSETTE

Make sure the window side is up, the rear label side is facing you and the arrow on the front of the cassette is pointing towards the VCR. Don't apply too much pressure when inserting.

- The VCR's power comes on automatically.
- If watching channel 3 or 4, press **TV/VIDEO** to select the VIDEO mode. VIDEO is displayed on the front display panel.
- The counter is automatically reset to "0H 00M 00S".
- If the cassette's record safety tab has been removed, playback begins automatically.

## 2 FIND PROGRAM START POINT

If the tape is advanced past the start point, press **REW**. To go forward, press **FF**.

## 3 START PLAYBACK

Press **PLAY**. "VIDEO CALIBRATION" appears on screen (☞ pg. 26).

## 4 STOP PLAYBACK

Press **STOP** or **STOP/EJECT**. Then press **STOP/EJECT** to remove the cassette.

### Usable cassettes

Full-Size VHS  
T-30 (ST-30\*\*)  
T-60 (ST-60\*\*)  
T-90  
T-120 (ST-120\*\*)  
T-160 (ST-160\*\*)  
ST-210\*\*

Compact VHS\*  
TC-20 (ST-C20\*\*)  
TC-30 (ST-C30\*\*)  
TC-40 (ST-C40\*\*)

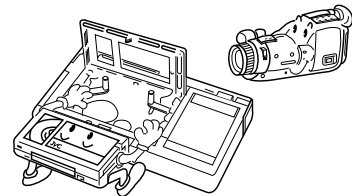

\* Compact VHS camcorder recordings can be played on this video recorder. Simply place the recorded cassette into a VHS Cassette Adapter and it can be used just like any full-sized VHS cassette.

\*\* This video recorder can record on regular VHS and Super VHS cassettes. However, it will record and play back regular VHS signals only. It is not possible to play back a recorded Super VHS tape.



# Simple Recording

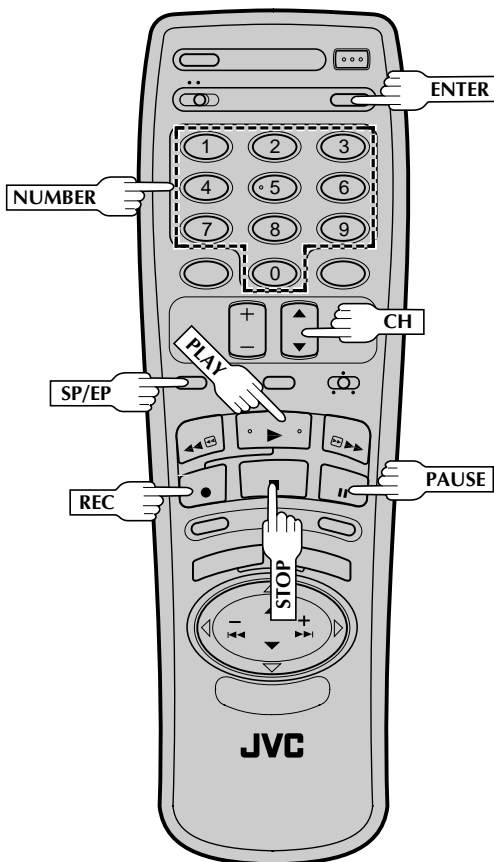
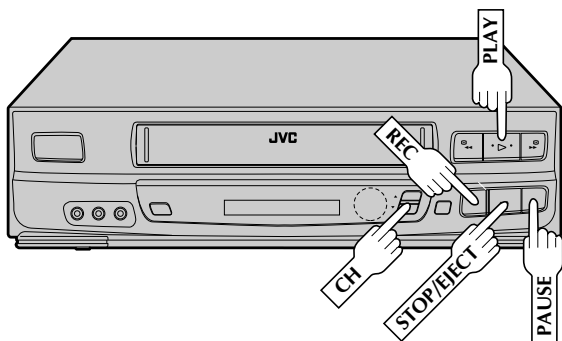

## 1 LOAD A CASSETTE

Make sure the record safety tab is intact. If not, cover the hole with adhesive tape before inserting the cassette.

## 2 SELECT RECORDING CHANNEL

Press **CH**▲▼. Or press the appropriate **NUMBER** keys, then press **ENTER**. (The channel changes after a few seconds whether you press **ENTER** or not.)

## 3 SET TAPE SPEED

Press **SP/EP** to set the recording speed.

## 4 START RECORDING

Press and hold **REC** and press **PLAY** on the remote control, or press **REC** on the VCR's front panel.

Active Video Calibration takes place at the beginning of both the first SP and the first EP recording after inserting the cassette (see pg. 25).

## 5 PAUSE/RESUME RECORDING

Press **PAUSE**. Press **PLAY** to resume recording.

## 6 STOP RECORDING

Press **STOP** or **STOP/EJECT**. Then press **STOP/EJECT** to remove the cassette.

### Accidental erasure prevention

- To prevent accidental recording on a recorded cassette, remove its record safety tab. To record on it later, cover the hole with adhesive tape.

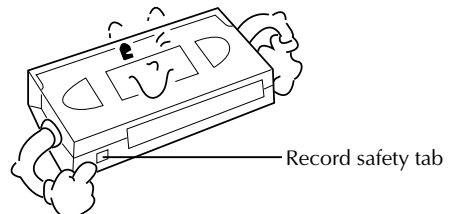

# Playback

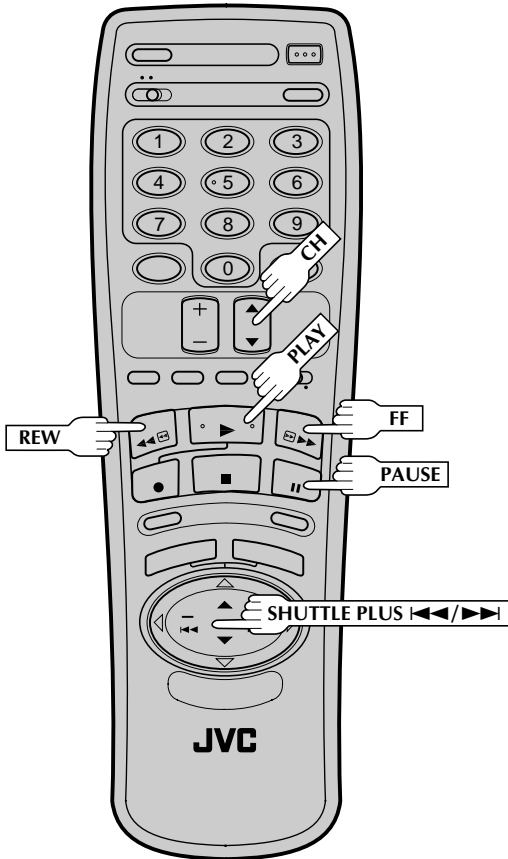
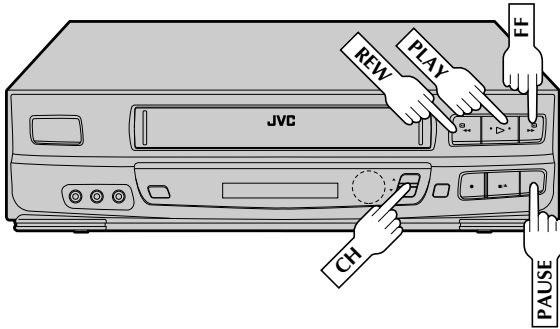

## Still Picture

### 1 PAUSE DURING PLAYBACK

Press **PAUSE**. If there is vertical jitter, press **CH▲** or **▼** on the VCR's front panel or remote to stabilize the picture.

### 2 FRAME-BY-FRAME PLAYBACK

Advance the tape one frame by pressing **PAUSE** again.

- To control direction, press **SHUTTLE PLUS ◀▶** or **▶▶** during still picture mode.

### 3 RESUME NORMAL PLAYBACK

Press **PLAY** during still picture mode.

## Slow, Reverse, Reverse Slow Or Fast-Motion Picture

### 1 DURING PLAYBACK

Press **SHUTTLE PLUS ◀▶** or **▶▶**.

- To increase the speed in the forward direction, press **▶▶**.
- To decrease the speed in the forward direction, press **◀▶**.
- To play in reverse slow motion, and in reverse play mode, continue to press **◀▶** after selecting all the forward slow motion modes.

Press **FF** for forward fast motion, or **REW** for reverse fast motion.

### 2 RESUME NORMAL PLAYBACK

Press **PLAY**.

## NOTES:

- Press and hold **FF** or **REW** for more than 2 seconds for short fast-motion searches. When the button is released, normal playback resumes.
- If noise bars appear during playback or slow motion, correct using manual tracking. (☞ pg. 17).





## Manual Tracking

Once playback begins, the VCR's automatic tracking function is engaged. If noise appears in the picture, you can override this and make the adjustment manually.

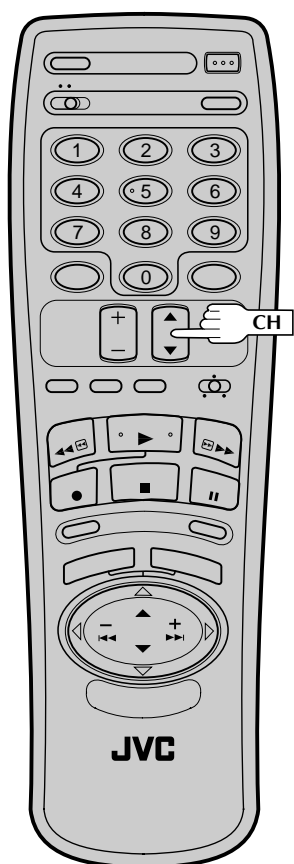
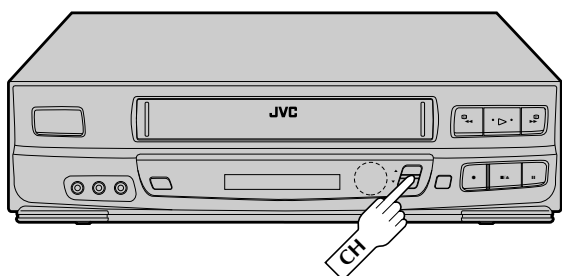

### ENGAGE MANUAL TRACKING MODE

1

During playback, press the **CH▲▼** buttons on the VCR's front panel simultaneously to cancel the automatic tracking mode and enable manual tracking adjust.

### ADJUST MANUAL TRACKING

2

Press **CH▲▼** on the VCR's front panel or remote. Press lightly for fine adjust, or press and hold for coarse adjust. Watch the screen and continue adjusting until optimum picture and sound quality are achieved.

### RE-ENGAGE AUTOMATIC TRACKING

3

Press the **CH▲▼** buttons on the VCR's front panel simultaneously.

- When automatic tracking is re-engaged, video calibration is automatically activated.

### NOTE:

During slow-motion playback, simply press **CH▲** or **▼** on the VCR's front panel or remote to adjust tracking.

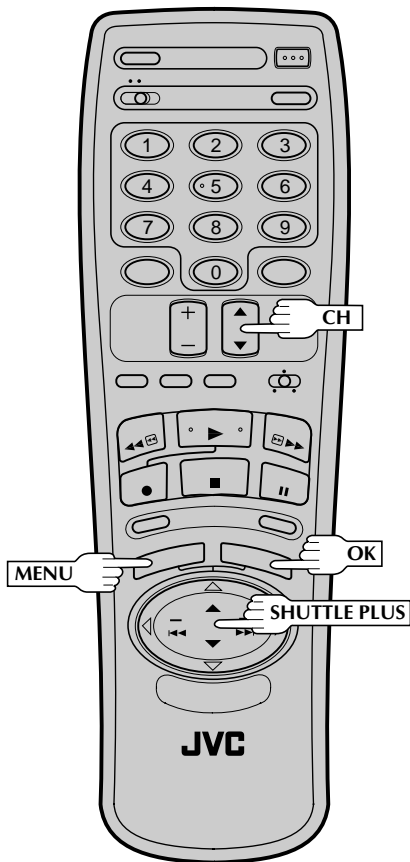
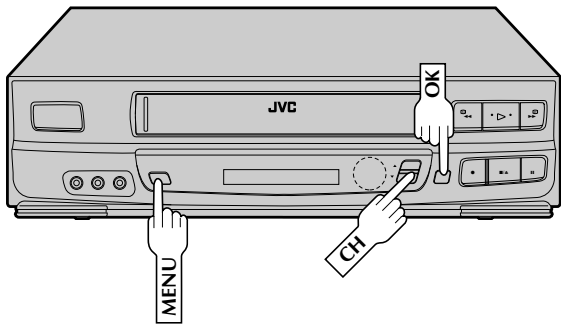

## Select The Soundtrack

Your VCR can record two soundtracks simultaneously (Normal and Hi-Fi) and play back the selected one, or both together.

1

### ACCESS MAIN MENU SCREEN

Press **MENU** during playback or when VCR is in stop mode.

2

### ACCESS FUNCTION SET SCREEN

Place the arrow next to "FUNCTION SET" by pressing **CH▲▼** or **SHUTTLE PLUS ▲▼**, then press **OK**.

3

### ACCESS AUDIO MONITOR SCREEN

Place the arrow next to "AUDIO MONITOR" by pressing **CH▲▼** or **SHUTTLE PLUS ▲▼**, then press **OK**.

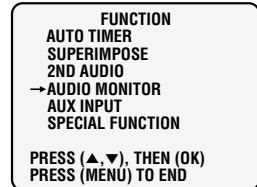

4

### SELECT MODE

You have three choices:

- a- Hi-Fi
- b- Normal
- c- Mix

Place the arrow next to your choice by pressing **CH▲▼** or **SHUTTLE PLUS ▲▼**.

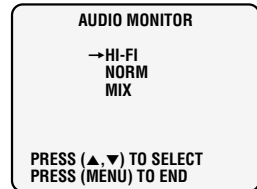

5

### RETURN TO NORMAL SCREEN

Press **MENU** as many times as necessary.

### NOTE:

*If the tape being played back has no Hi-Fi soundtrack, the Normal soundtrack will be heard no matter what choice you make at the Audio Monitor screen.*

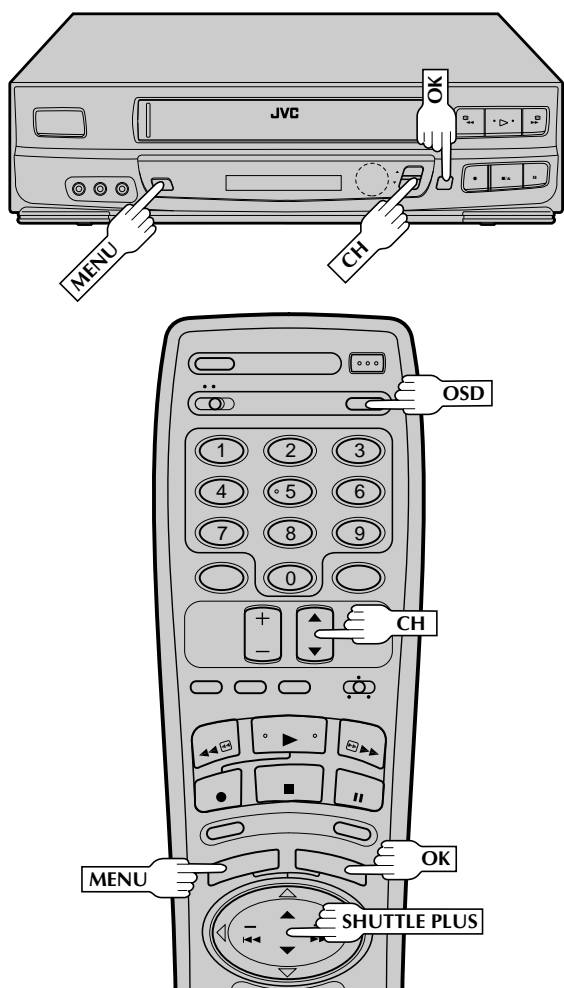

**To recall an indication**

- 1 Press **OSD**.
  - All indications corresponding to the current status are displayed for 5 seconds, leaving the counter information, and RECORD/PAUSE if in the Record Pause mode, on the screen. (No indication during still and search.)
- 2 Press **OSD** again to clear the display.

**Superimpose**

This function, switchable between ON and OFF, determines whether or not operational indicators will appear on screen.

- 1 **ACCESS MAIN MENU SCREEN**  
Press **MENU**.
- 2 **ACCESS FUNCTION SET SCREEN**  
Place the arrow next to "FUNCTION SET" by pressing **CH▲▼** or **SHUTTLE PLUS ▲▼**, then press **OK**.
- 3 **ACCESS SUPERIMPOSE SCREEN**  
Place the arrow next to "SUPERIMPOSE" by pressing **CH▲▼** or **SHUTTLE PLUS ▲▼**, then press **OK**.
 

FUNCTION

AUTO TIMER  
→ SUPERIMPOSE  
2ND AUDIO  
AUDIO MONITOR  
AUX INPUT  
SPECIAL FUNCTION

PRESS (▲, ▼), THEN (OK)  
PRESS (MENU) TO END
- 4 **SELECT MODE**  
Place the arrow next to "ON" or "OFF" by pressing **CH▲▼** or **SHUTTLE PLUS ▲▼**.
 

SUPERIMPOSE

→ ON  
OFF

PRESS (▲, ▼) TO SELECT  
PRESS (MENU) TO END
- 5 **RETURN TO NORMAL SCREEN**  
Press **MENU** as many times as necessary.

**NOTE:**

If you engage the Record Pause mode, RECORD/PAUSE is displayed whether "SUPERIMPOSE" is set to "ON" or "OFF".

**The superimposed indication on the TV screen tells you what the VCR is doing.**

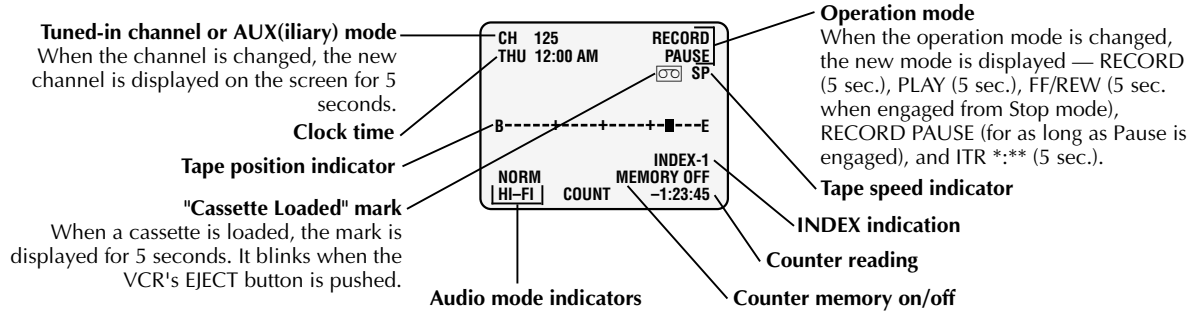

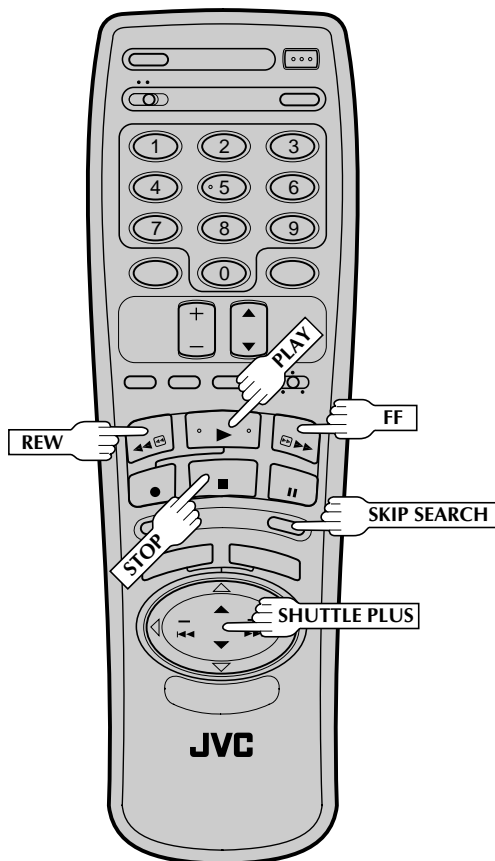
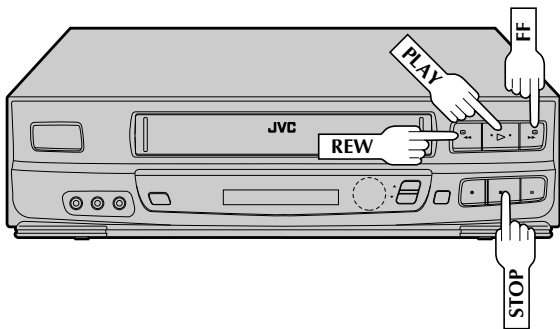

## Skip Search

1

### SKIP OVER UNWANTED SECTIONS

Press **SKIP SEARCH** 1 to 4 times during playback. Each press initiates a 30-second period of fast-motion playback. Normal playback resumes automatically.

#### NOTE:

To return to normal playback during a Skip Search, press **PLAY**.

## Repeat Playback

1

### START REPEAT

Press and hold **PLAY** (until "PLAY" blinks on the front display panel) during playback, then release.

- The entire tape is played back 20 times.

2

### STOP REPEAT

To stop, press **STOP** at any time.

#### NOTE:

Pressing **PLAY**, **REW**, **FF**, **PAUSE** or **SHUTTLE PLUS** ◀◀ or ▶▶ also stops Repeat Playback.

## Index Search

This function seeks out index codes that are placed on the tape at recording start.

1

### START SEARCH

While the tape is stopped, press **SHUTTLE PLUS** ◀◀ or ▶▶.

2

### ACCESS DISTANT CODE

To access a recording 2–9 index codes away, press **SHUTTLE PLUS** ◀◀ or ▶▶ repeatedly until the correct number is displayed on screen (only if **SUPERIMPOSE** is set to ON (pg. 19)). Playback begins automatically when desired recording is located.

- To find the very beginning of the desired program, press **REW** or **FF** and search visually for the start point.

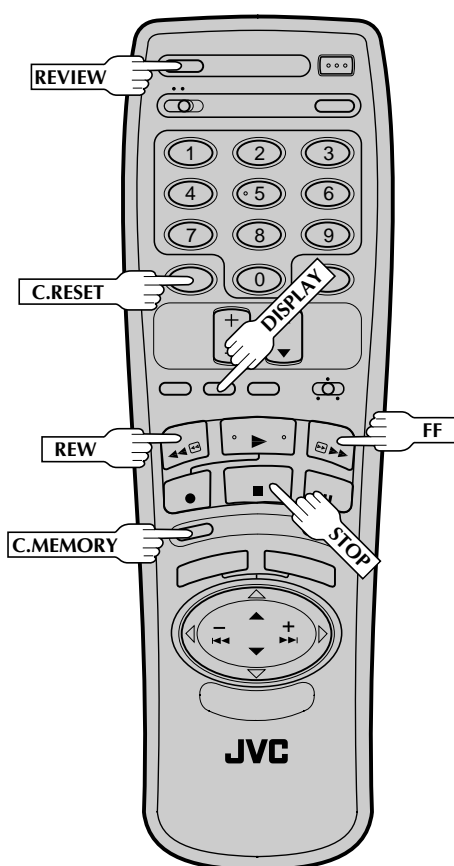
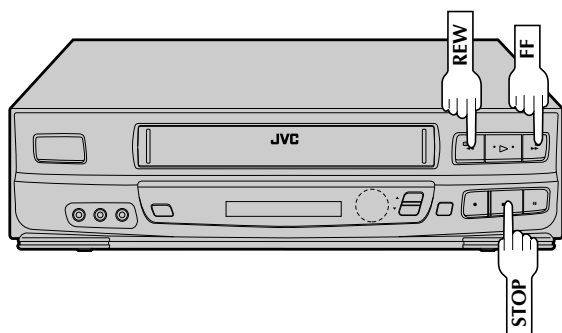

## Instant ReView

At the press of a button, you can power up your VCR, rewind the tape and begin viewing the most recent timer-recorded program.

1

### ACTIVATE INSTANT REVIEW

After ensuring that the VCR is off and the Timer mode is disengaged, press **REVIEW**.

- The power comes on and the VCR searches for the index code indicating the start of the last timer-recorded program, then begins playback automatically.
- You can access a program 2–9 index codes away from the current position on the tape. If, for example, you have 5 programs recorded and you want to watch the third one, press **REVIEW** three times.
- To find the very beginning of the desired program, press **REW** or **FF** and search visually for the program's start point.

## Counter Reset

1

### RESET COUNTER TO ZERO

Press **C.RESET**.

#### NOTE:

By pressing the **DISPLAY** button, you can change the display to show the counter reading, channel number or clock time. (Channel number is not displayed during playback.)

## Counter Memory

When activated, this feature returns the tape to counter position "zero".

1

### ACTIVATE COUNTER MEMORY

Press **C.RESET** during playback at a point you want to have quick access to later. The counter reads "0H 00M 00S".

Then press **C.MEMORY**. The Counter Memory indicator in the front display panel lights.

2

### RETURN TO COUNTER POSITION ZERO

Press **STOP** (during playback), then press **REW**. The tape rewinds and stops at approximately "0H 00M 00S" automatically.

- To cancel Counter Memory, press **C.MEMORY**.

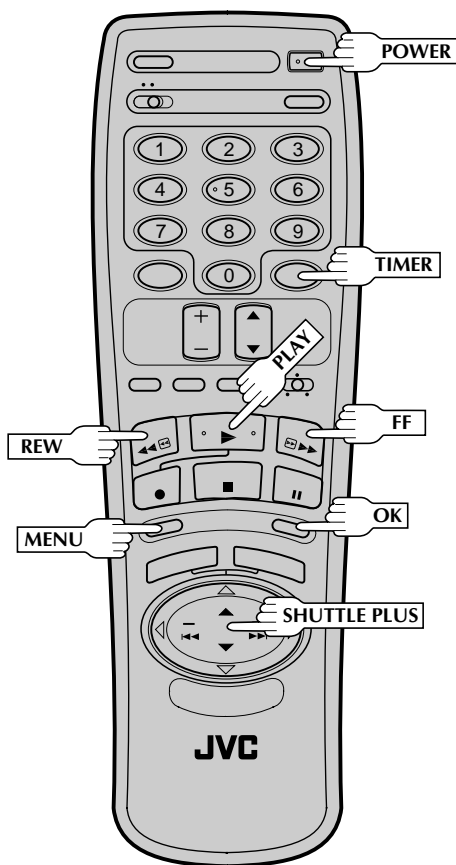
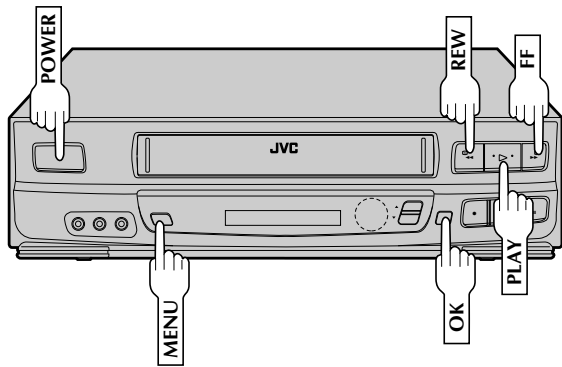

## Tape Position Indicator

The Tape position indicator appears on screen when, from the stop mode, you press **FF**, **REW** or perform an Index Search or Instant ReView. The position of "■" in relation to "B" (Beginning) or "E" (End) shows you where you are on the tape.

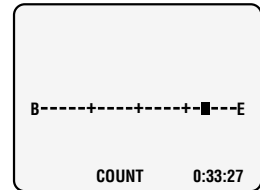

\*\* SUPERIMPOSE must be set to ON, or the indicator will not appear (pg. 19).

## Next-Function Memory

The Next Function Memory "tells" the VCR what to do after rewinding.

- \* Before continuing, ensure that the VCR is in stop mode.
- a- For Automatic Start Of Playback After Tape Rewind . . .  
... press **REW**, then press **PLAY** within 2 seconds.
- b- For Automatic Power Off After Tape Rewind . . .  
... press **REW**, then press **POWER** within 2 seconds.
- c- For Automatic Timer Standby After Tape Rewind . . .  
... press **REW**, then press **TIMER** within 2 seconds.

## AV COMPU LINK Playback

Your VCR is compatible with JVC's AV COMPU LINK components, including amplifiers, receivers, and televisions.

### MAKE CONNECTION

1 Connect your VCR to an AV COMPU LINK component as shown in the illustration on page 23.

- The AV COMPU LINK cable is a mono 3.5 mm mini-plug to mono 3.5 mm mini-plug connector.

### TURN ON THE VCR

2 Press **POWER**.

### ACCESS MAIN MENU SCREEN

3 Press **MENU**.

### ACCESS FUNCTION SET SCREEN

4 Press **CH▲▼** or **SHUTTLE PLUS ▲▼** to place the arrow next to "FUNCTION SET", then press **OK**.

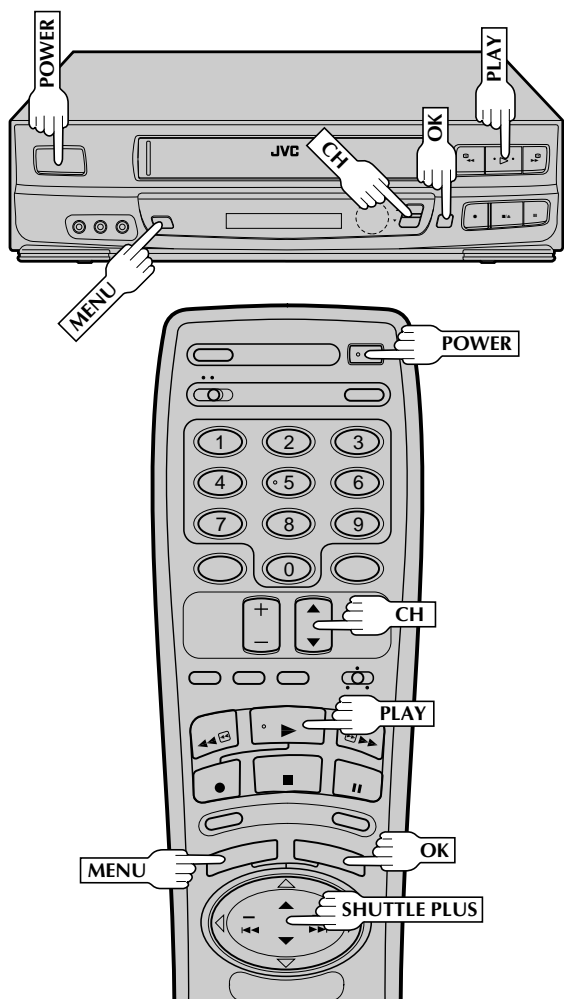

5

### ACCESS SPECIAL FUNCTION SCREEN

Press **CH▲▼** or **SHUTTLE PLUS ▲▼** to place the arrow next to "SPECIAL FUNCTION", then press **OK**.

FUNCTION AUTO TIMER SUPERIMPOSE 2ND AUDIO AUDIO MONITOR AUX INPUT → SPECIAL FUNCTION  PRESS (▲, ▼), THEN (OK) PRESS (MENU) TO END
--

6

### ENABLE AV COMPU LINK PLAYBACK

Press **CH▲▼** or **SHUTTLE PLUS ▲▼** to place the arrow next to "AV COMPU LINK".

SPECIAL FUNCTION  PAUSE → AV COMPU-LINK  PRESS (▲, ▼) TO SELECT PRESS (MENU) TO END
---

7

### RETURN TO NORMAL SCREEN

Press **MENU** as many times as necessary.

8

### PERFORM AV COMPU LINK PLAYBACK

Simply insert a cassette and press **PLAY** (if the cassette's record safety tab has been removed, playback begins automatically). Linked components are turned on, and the TV set to its VIDEO mode, automatically!

Example

Your VCR

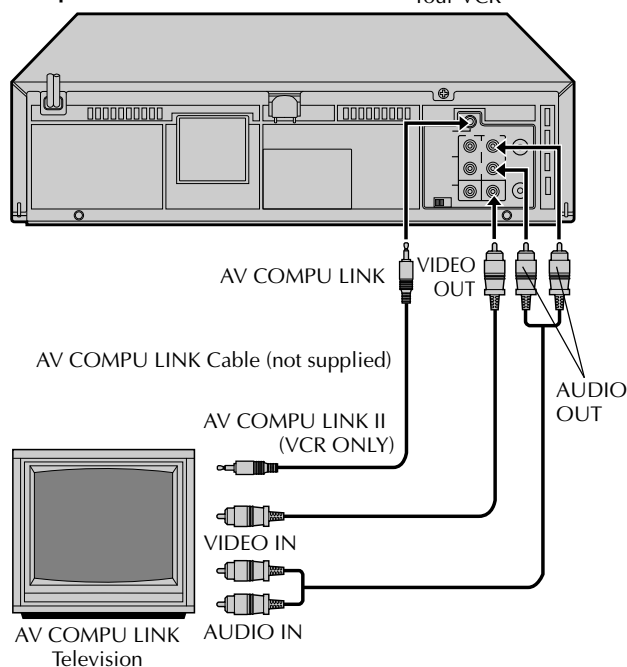

### NOTE:

Connection varies depending on the type of TV you have. Please refer to the TV's instruction manual when making this connection.

# Active Video Calibration

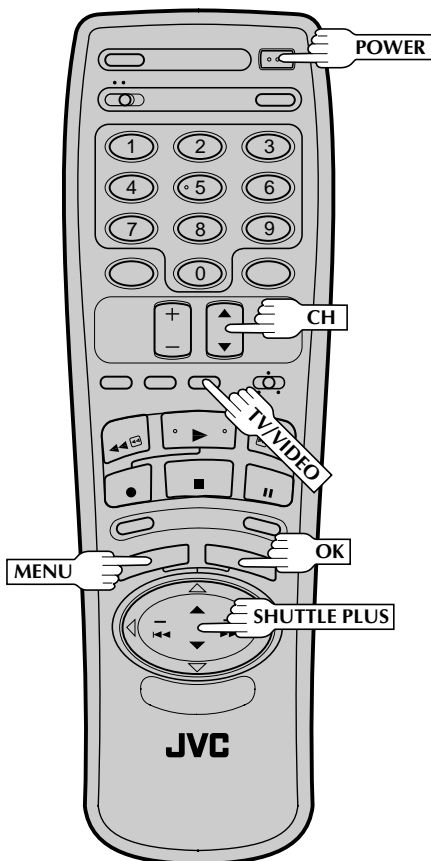
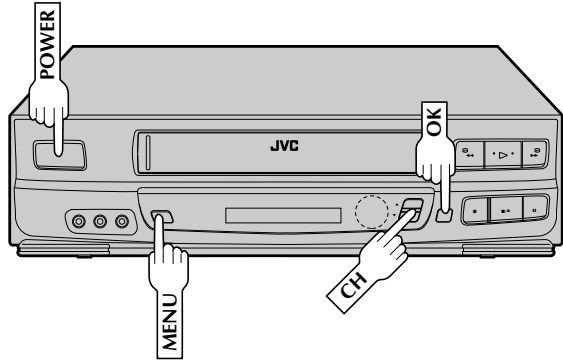

Your VCR is equipped with the Active Video Calibration feature, which checks the condition of the tape in use during recording and playback, and compensates to provide the highest-possible recording and playback pictures. \*The default setting for both recording and playback is "ON".

## Preparation

### 1 TURN ON THE VCR

Press **POWER**. If watching channel 3 or 4, press **TV/VIDEO** to select the VIDEO mode. VIDEO is displayed on the front display panel.

### 2 ACCESS MAIN MENU SCREEN

Press **MENU**.

### 3 ACCESS VIDEO CALIBRATION SCREEN

Press **CH▲▼** or **SHUTTLE PLUS▲▼** to place the arrow next to "VIDEO CALIBRATION", then press **OK**.

MAIN MENU	
PROGRAM SET	
FUNCTION SET	
TUNER SET	
CUSTOM SET	
→ VIDEO CALIBRATION	
PRESS (▲, ▼), THEN (OK)	
PRESS (MENU) TO END	

### 4 SELECT MODE

Place the arrow next to "ON" by pressing **CH▲▼** or **SHUTTLE PLUS▲▼**, then press **OK** to move the arrow to the Playback section. Set Playback to "ON", then press **MENU** as many times as necessary to return to the normal screen. (Pressing **OK** returns the arrow to the Recording section.)

ACTIVE VIDEO CALIBRATION	
RECORDING	→ ON OFF
PLAYBACK	→ ON OFF
PRESS (▲, ▼), THEN (OK)	
PRESS (MENU) TO END	



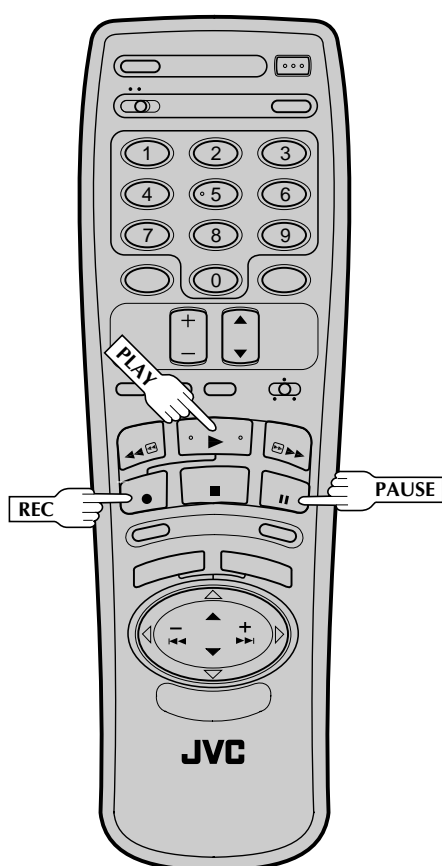
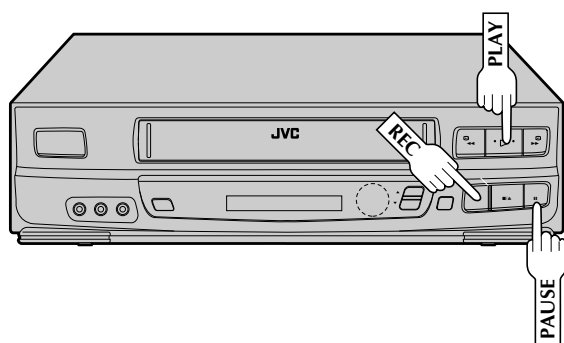

## Recording

Perform steps 1 – 3 on page 15 ("Simple Recording") before continuing.

### 1

Press and hold **REC** and press **PLAY** on the remote control, or press **REC** on the VCR's front panel.

- The VCR takes about 7 seconds to assess the quality of the tape in use, then recording begins with the picture level optimized.

### NOTES:

- Calibration occurs immediately prior to both the first SP and the first EP recording after inserting the cassette. It does not take place during recording.
- In the case of timer recording, calibration takes place for both SP and EP before the first timer recording after inserting the cassette (regardless of the tape speed selected for that recording).
- Once the cassette is ejected, the calibration data is canceled. The next time the cassette is used for recording, calibration is re-performed.
- SUPERIMPOSE must be set to "ON" or the Active Video Calibration screen will not appear (☞ pg. 19).

### DURING CALIBRATION

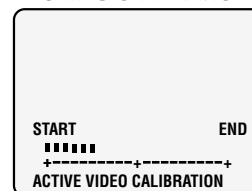

### CALIBRATION COMPLETE

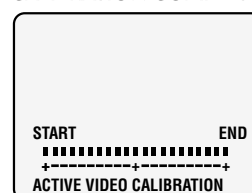

### ATTENTION:

- As calibration takes place before recording actually starts, there is a delay of about 7 seconds after **REC** and **PLAY** on the remote, or **REC** on the VCR's front panel, are pressed. To make sure you record the desired scene or program completely, first perform the following steps:
  - 1) Press and hold **PAUSE**, and press **REC** to engage the RECORD PAUSE mode.
    - The VCR then automatically checks the condition of the tape and, after about 7 seconds, re-enters RECORD PAUSE.
  - 2) Press **PLAY** to start recording.
- If you want to bypass Active Video Calibration and start recording right away, set "RECORDING" to "OFF" in step 4 of the Preparation procedure (☞ pg. 24).

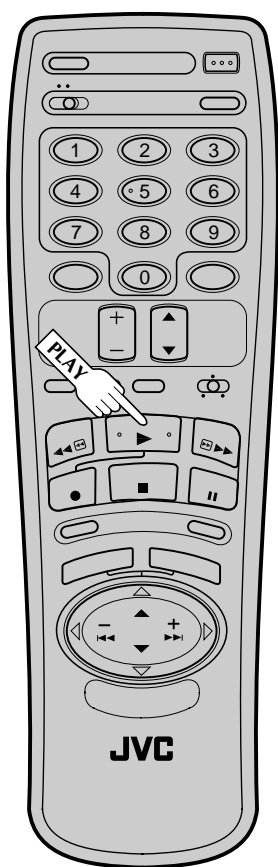
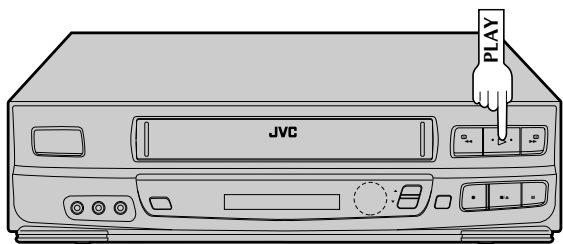

### Playback

The VCR assesses the quality of the tape once you initiate playback.

Before beginning, perform steps 1 and 2 on page 14.

### START PLAYBACK

# 1

Press **PLAY**.

- The VCR adjusts the playback picture quality based on the quality of the tape in use.



### NOTES:

- When using rental tapes, or tapes recorded on other VCRs, set "PLAYBACK" in step 4 of the Preparation procedure to either "ON" or "OFF" as desired.
- The Video Calibration screen only appears at the beginning of automatic tracking. Even though the screen doesn't appear after that, the Active Video calibration function is operative.
- SUPERIMPOSE must be set to "ON" or the Video Calibration screen will not appear (pg. 19).



# Recording

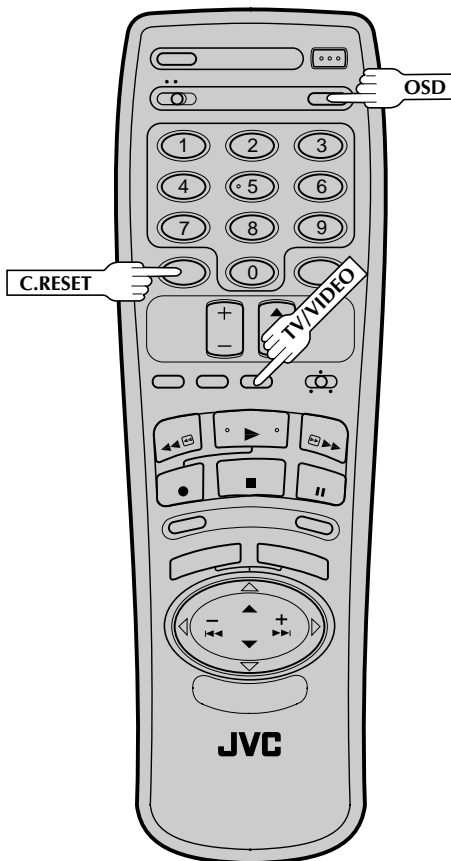
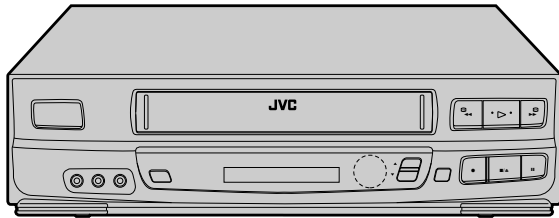

## Record One Program While Watching Another

**1**

### ENGAGE TV MODE

During recording...

- If using the RF connection (☞ pg. 6), press **TV/VIDEO**. The VCR's VIDEO indicator goes out and the TV broadcast being recorded disappears.
- If using the AV connection (☞ pg. 6), change the TV's input mode from AV to TV.

**2**

### SELECT CHANNEL FOR VIEWING

Use the TV's channel selector to set the channel you want to watch.

## Display Elapsed Recording Time

**1**

### RESET COUNTER TO ZERO

Before recording starts, press **C.RESET**. The counter resets to zero and displays the exact elapsed time as the tape runs.

**2**

### DISPLAY ELAPSED TIME ON SCREEN

During recording, press **OSD** at any time to see the elapsed time. All indications corresponding to the current status of the VCR are displayed for 5 seconds. The counter display remains on the screen indicating the elapsed time. Press **OSD** again to remove the display.

- Make sure "SUPERIMPOSE" is set to "ON" (☞ pg. 19).

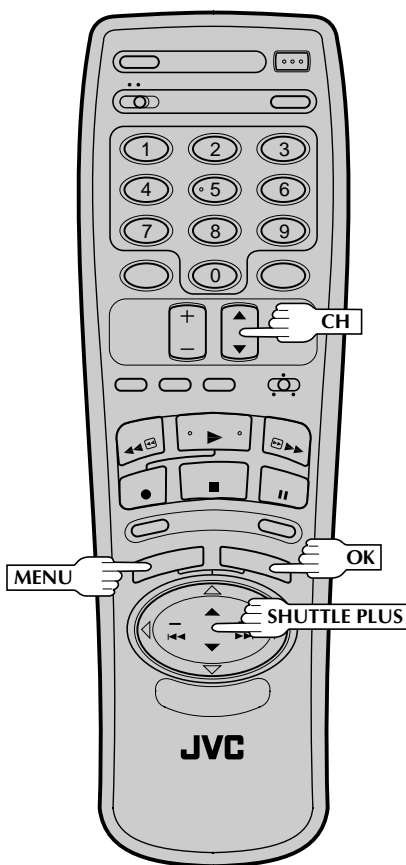
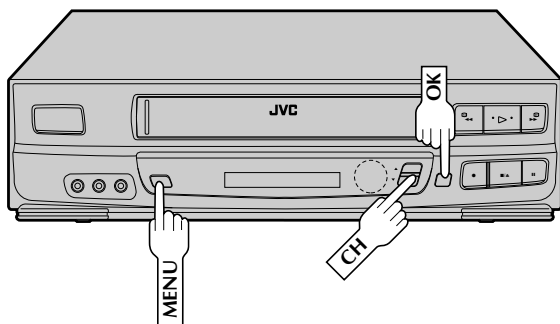

## Stereo And SAP (Second Audio Program)

Your VCR's built-in MTS decoder enables reception of Multi-channel TV Sound broadcasts.

- The ST indicator on the front display panel lights during stereo broadcast reception, and SAP lights during SAP program reception.
- Both indicators light when a stereo program is accompanied by SAP audio.

### To Record Stereo Programs . . .

. . . simply follow the basic recording procedure.

### To Listen To Stereo Soundtrack During Recording . . .

. . . select "HI-FI" at the Audio Monitor screen (pg. 18).

## To Record SAP Programs . . .

### 1 ACCESS MAIN MENU SCREEN

Press MENU.

### 2 ACCESS FUNCTION SET SCREEN

Place the arrow next to "FUNCTION SET" by pressing CH▲▼ or SHUTTLE PLUS ▲▼, then press OK.

### 3 ACCESS 2ND AUDIO SCREEN

Place the arrow next to "2ND AUDIO" by pressing CH▲▼ or SHUTTLE PLUS ▲▼, then press OK.

### 4 SELECT MODE

Place the arrow next to "ON" by pressing CH▲▼ or SHUTTLE PLUS ▲▼.

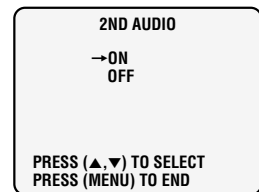

### 5 RETURN TO NORMAL SCREEN

Press MENU as many times as necessary.

## NOTES:

- If a SAP program is received, the SAP audio is recorded on both the Normal and Hi-Fi tracks. The main audio program is not recorded.
- If a non-SAP program is received, the main audio is recorded on both the Hi-Fi and Normal audio tracks.



# Instant Timer Recording (ITR)

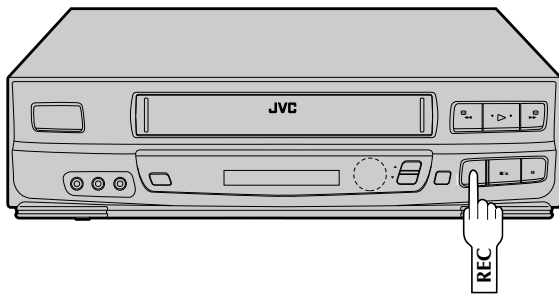

This easy method lets you record for from 30 minutes to 6 hours (selectable in 30-min. increments), and shuts the VCR off after recording is finished.

## START RECORDING

Press **REC**.

## ENGAGE ITR MODE

Press **REC** again. ITR blinks and 0:30 appears on the front display panel.

## SET RECORDING DURATION

If you want to record for more than 30 minutes, press **REC** to extend the time. Each press extends recording time by 30 minutes.

### NOTES:

- You can only perform ITR using the **REC** button on the VCR's front panel.
- After you set the time, the previous display reappears.
- To check remaining recording time, press **REC** once during recording and the remaining time is displayed for about 5 seconds. Be careful not to press again during this 5 seconds, or you'll add 30 more minutes to the recording.

# On-Screen Timer Programming

\* Refer to the illustration on page 30.

You can directly program the VCR's timer to record up to 8 shows, as far as a year in advance. Remember, the clock must be set before you can program the timer (☞ pg. 7).

## LOAD A CASSETTE

Make sure the record safety tab is intact. If not, cover the hole with adhesive tape, then load.

- The VCR comes on, and the counter is reset, automatically.

## ACCESS PROGRAM SET SCREEN

Press **MENU**, then press **OK**.

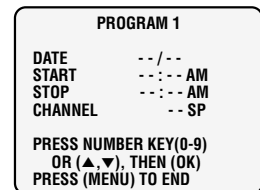

CONTINUED ON NEXT PAGE.

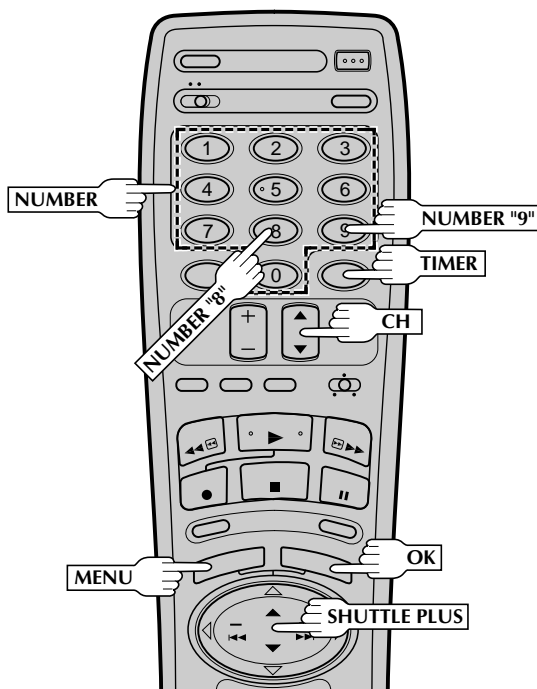
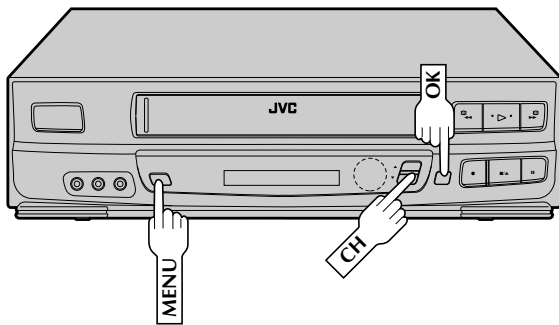
**EXAMPLE**

If you program the VCR to timer record a show on September 6 on channel 40 from 12:00 noon to 1:00 PM in SP mode, the screen will look like this:

PROGRAM 1	
DATE	9/6 SUN
START	12:00 PM
STOP	1:00 PM
CHANNEL	40 SP
PRESS NUMBER KEY(0-9) OR (▲, ▼), THEN (OK) PRESS (MENU) TO END	

**NOTES:**

- To disengage the timer before recording starts, press **TIMER** again. Pressing once more re-engages it.
- In case of a power failure after programming, the VCR's memory backup keeps your selections for 10 minutes.
- If you select "PROGRAM SET" without having set the date and time, an error message appears. Follow its instructions.
- If you enter a start time that has already passed, **ERROR** appears on the screen and flashes.
- Programs that start after midnight must have the next day's date.

3

**SELECT PROGRAM NUMBER**

Press the appropriate **NUMBER** keys or **CH▲▼** or **SHUTTLE PLUS ▲▼** to select a vacant program number, then press **OK**. The first time you do this, all numbers will be vacant, so just press **OK** when the screen appears.

4

**SET PROGRAM INFORMATION**

Press the appropriate **NUMBER** keys to set the date, start/stop time and channel number. Press **CH▲▼** or **SHUTTLE PLUS ▲▼** to set AM/PM and tape speed. Then press **OK** after AM/PM, channel number and tape speed settings. The next setting that can be set begins flashing.

- Any information comprised of 1 digit (except the channel number) should have a "0" entered before it.
- It is possible to set all information using the **CH▲▼** or **SHUTTLE PLUS ▲▼** buttons. (In this case, press **OK** after each setting.)

**NOTE:**

If you are using a cable box, enter the cable box channel, not the channel to be recorded. The channel to be recorded must be selected on the cable box. (The cable box channel is the VCR's channel that displays the channels received by the cable box.)

\*\* You can record selected programs at the same time every weekday, or once a week. Before entering the month, press **NUMBER** key "8" (DAILY) or "9" (WEEKLY). Either "DAILY" or "WEEKLY" appears. Press again and "DAILY" or "WEEKLY" disappears.

5

**MAKE CORRECTIONS**

To change any of the settings, press **OK** or **SHUTTLE PLUS ◀▶** until the item you want to change begins blinking. Then set as in step 4.

6

**RETURN TO NORMAL SCREEN**

Press **MENU** as many times as necessary.

- Press just once to access the Auto Timer screen (see pg. 32).

7

**ENGAGE TIMER MODE**

Press **TIMER**. The VCR turns off automatically.

- After timer recording is completed, the VCR's power goes off automatically.
- You can program the timer while a regular recording is in progress; the on-screen menu will not be recorded.
- If the end of tape is reached during timer recording, the cassette is automatically ejected.
- When timer-recording cable channels received through a Cable Box, be sure to keep the Cable Box set to ON.

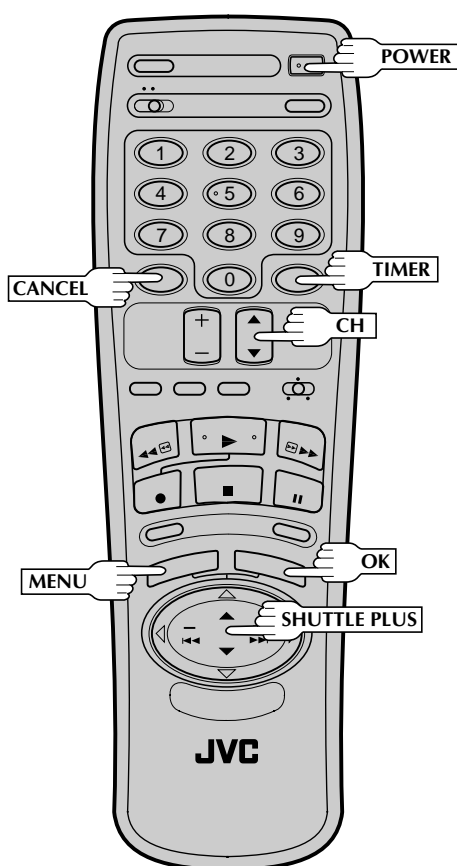
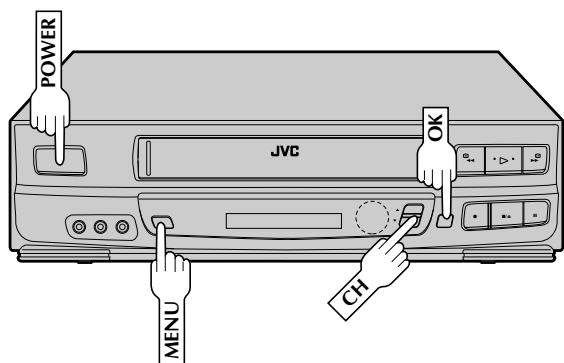

## Check And Cancel Programs

1

### DISENGAGE TIMER

Press **TIMER**, then press **POWER**.

2

### ACCESS PROGRAM SET SCREEN

Press **MENU**, then press **OK**.

3

### CHECK PROGRAM INFORMATION

Press **CH▲▼** or **SHUTTLE PLUS ▲▼** to check the programs in succession.

## To Cancel A Program . . .

4

### CANCEL A PROGRAM

Press **CANCEL**.

- Repeat steps 3 and 4 as many times as necessary.

5

### RETURN TO NORMAL SCREEN

Press **MENU** as many times as necessary. If there are still programs remaining, go to step 6.

6

### RE-ENGAGE TIMER

Press **TIMER** again.

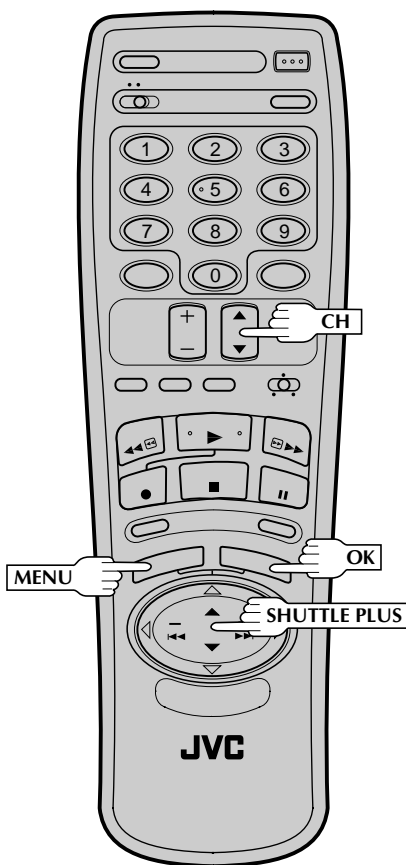
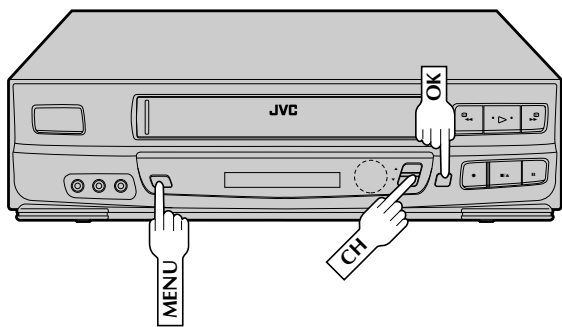

### Auto Timer

When activated, this function engages the timer when the VCR is turned off, and disengages it when the power is turned on, automatically.

- 1** **ACCESS MAIN MENU SCREEN**  
Press **MENU**.
- 2** **ACCESS FUNCTION SET SCREEN**  
Place the arrow next to "FUNCTION SET" by pressing **CH▲▼** or **SHUTTLE PLUS ▲▼**, then press **OK**.
- 3** **ACCESS AUTO TIMER SCREEN**  
Place the arrow next to "AUTO TIMER" by pressing **CH▲▼** or **SHUTTLE PLUS ▲▼**, then press **OK**. Now skip to step 2 of the procedure below.

Or, during on-screen timer programming ...

- 1** **ACCESS FUNCTION SET SCREEN**  
In step 5 in the On-Screen Timer Programming procedure (pg. 30), press **MENU**.
- 2** **SELECT MODE**  
Place the arrow next to your choice ("ON" or "OFF") by pressing **CH▲▼** or **SHUTTLE PLUS ▲▼**.
 

AUTO TIMER

→ ON  
OFF

PRESS (▲, ▼) TO SELECT  
PRESS (MENU) TO END
- 3** **RETURN TO NORMAL SCREEN**  
Press **MENU**.



# Edit To Or From Another VCR

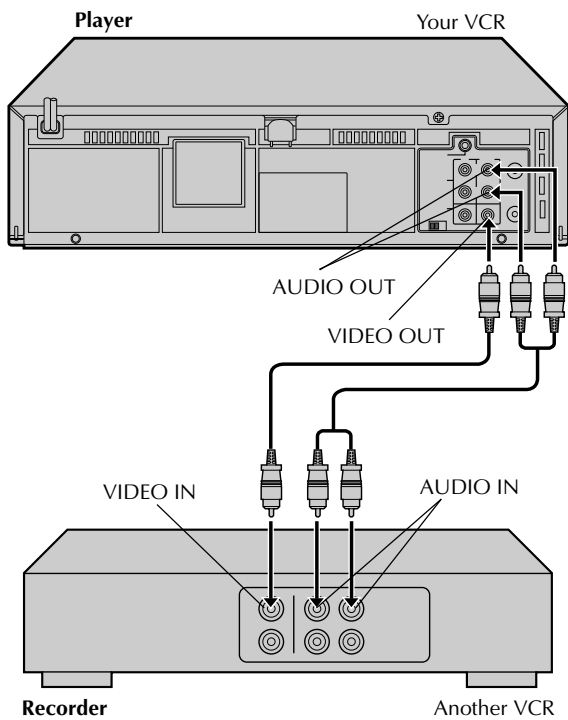

You can use your VCR as the player or the recorder.

## 1 MAKE CONNECTIONS

Connect an AV cable (not supplied) between the player's VIDEO OUT and AUDIO OUT connectors and the recorder's VIDEO IN and AUDIO IN connectors.

- When using your VCR as the recorder and a monaural VCR as the player, connect the player's AUDIO OUT connector to the AUDIO IN L connector on the recorder.

## 2 LOAD CASSETTES

Insert the playback cassette into the player and the cassette to be recorded on into the recorder.

## 3 SET RECORDER'S INPUT MODE

Set to AUX. With this VCR, press **NUMBER** key "0" (AU appears on the front display panel in place of a channel number).

### NOTE:

When using this VCR as the recorder, make sure to select "FRONT" or "REAR" (depending on which input connectors you use) at the Aux Input Screen. (To select the correct AUX input connector, follow steps 4, 5, 9 – 11 from the "Edit From A Camcorder" section, pg. 42.)

## 4 START PLAYER

Set to its play mode.

## 5 START RECORDER

Set to its record mode.

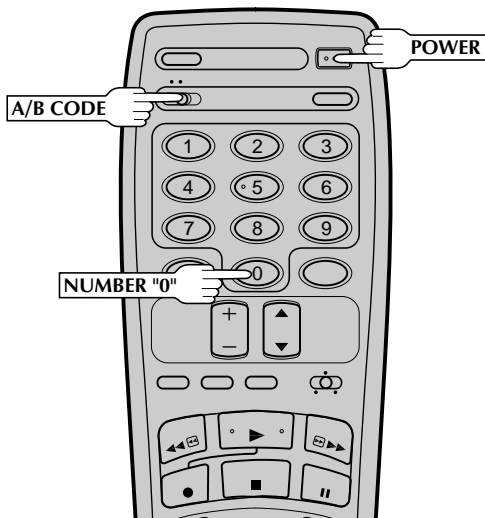

## Control Two JVC VCRs

The supplied remote control is capable of controlling two JVC VCRs independently using the **A/B CODE** switch. You can set this VCR so it responds to remote commands only when the switch is set to **B**, and another VCR so it responds to commands when the switch is set to **A**. The switch is preset to **A** because this VCR normally responds to A-code signals. You can easily modify this VCR to accept B-code commands.

- 1 Unplug the VCR's power cord from the AC outlet.
- 2 Set the **A/B CODE** switch on the remote control to **B**.
- 3 Plug the VCR's power cord back into the AC outlet.
- 4 Turn the VCR's power back on by pressing **POWER** on the remote.

The VCR will now respond only to B-code commands.

# Edit From A Camcorder

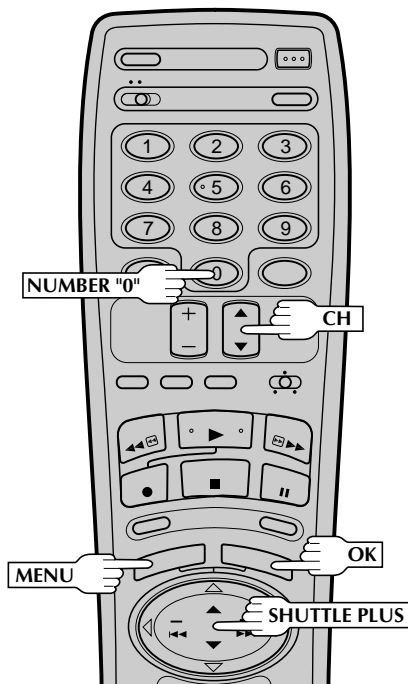
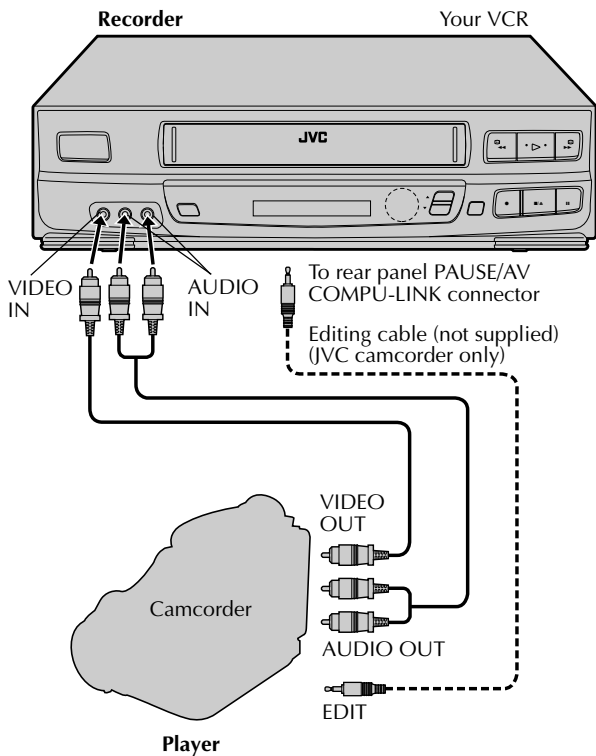

You can use a camcorder as the player and your VCR as the recorder.

## 1 MAKE CONNECTIONS

Connect an AV cable (not supplied) between the camcorder's VIDEO OUT and AUDIO OUT connectors and your VCR's VIDEO IN and AUDIO IN connectors.

- When a Master Edit Control-equipped JVC camcorder is used, the camcorder is capable of controlling your VCR. The editing cable is a mono 3.5 mm mini-plug to mono 3.5 mm mini-plug connector.

## 2 LOAD A CASSETTE

Insert the cassette to be recorded on into the recorder.

## 3 SET RECORDER'S INPUT MODE

Press **NUMBER** key "0" to set to AUX.

## 4 ACCESS MAIN MENU SCREEN

Press **MENU**.

## 5 ACCESS FUNCTION SET SCREEN

Press **CH▲▼** or **SHUTTLE PLUS ▲▼** to place the arrow next to "FUNCTION SET", then press **OK**.

*If you're using a JVC Master Edit Control-equipped camcorder — step 6  
If not — step 9*

## 6 ACCESS SPECIAL FUNCTION SCREEN

Press **CH▲▼** or **SHUTTLE PLUS ▲▼** to place the arrow next to "SPECIAL FUNCTION", then press **OK**.

## 7 SELECT MODE

Press **CH▲▼** or **SHUTTLE PLUS ▲▼** to place the arrow next to "PAUSE".

**SPECIAL FUNCTION**

→PAUSE  
AV COMPU-LINK

PRESS (▲,▼) TO SELECT  
PRESS (MENU) TO END

## 8 RETURN TO FUNCTION SET SCREEN

Press **MENU**.

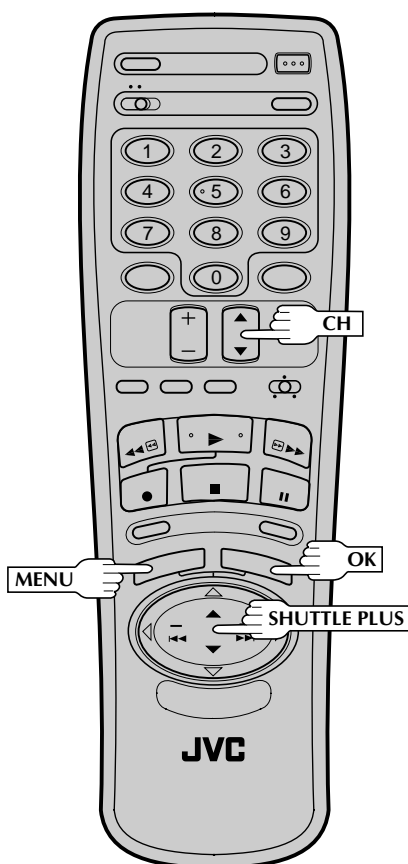
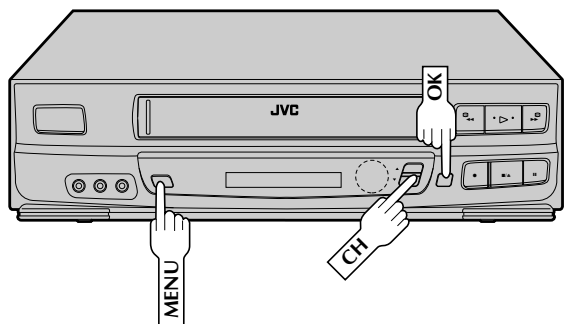

## 9 ACCESS AUX INPUT SCREEN

Press **CH▲▼** or **SHUTTLE PLUS ▲▼** to place the arrow next to "AUX INPUT", then press **OK**.

## 10 SELECT INPUT

If you are connecting the AV cable to the AV connectors on the front of the VCR, place the arrow next to "FRONT" by pressing **CH▲▼** or **SHUTTLE PLUS ▲▼**. If you are connecting the AV cable to the AV connectors on the back of the VCR, place the arrow next to "REAR" by pressing **CH▲▼** or **SHUTTLE PLUS ▲▼**.

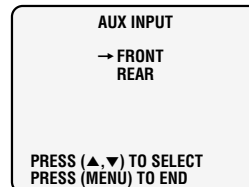

## 11 RETURN TO NORMAL SCREEN

Press **MENU** as many times as necessary.

## 12 START PLAYER

Set the camcorder to its play mode.

## 13 START RECORDER

Set your VCR to its record mode.

- If you are using a Master Edit Control-equipped JVC camcorder, it can put the recorder automatically into Play mode. (Refer to camcorder's instruction manual.)

# Assemble Editing

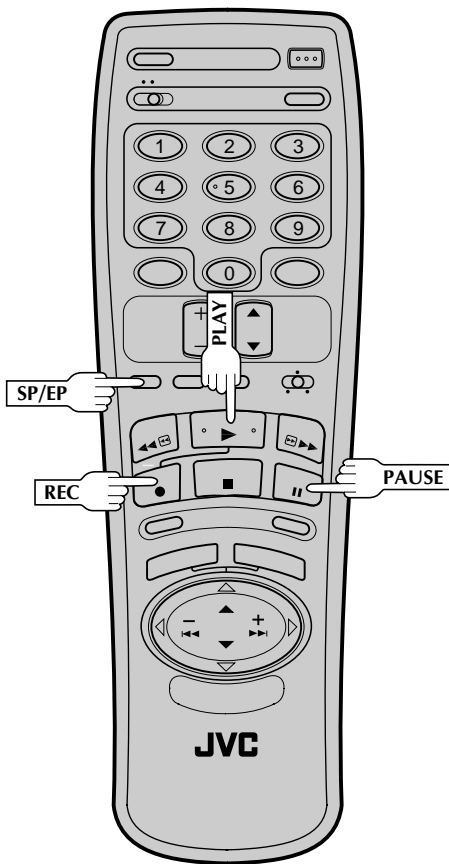
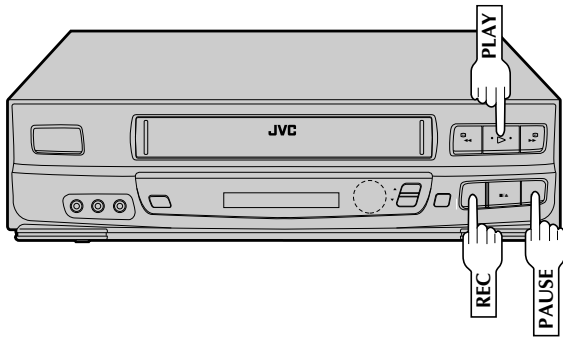

Assemble Editing adds one recorded scene to another in succession.  
To use your VCR as the recorder ...

- 1 LOAD CASSETTES**  
Insert the original cassette in the player, and the recording cassette in the recorder.
- 2 SET TAPE SPEED**  
Set to "SP" or "EP" by pressing the **SP/EP** button on the remote control.
- 3 ENGAGE RECORD-STANDBY MODE**  
Press and hold **PAUSE**, and press **REC**.
- 4 FIND EDIT START POINT**  
Play back the original tape until you reach the scene to be edited.
- 5 START EDITING**  
When you reach the scene on the original tape to be edited, press **PLAY** to initiate the recorder's record mode.
- 6 STOP EDITING**  
Press **PAUSE** to pause the tape in the recorder.
- 7 CONTINUE EDITING**  
Repeat steps 4 through 6 to add additional scenes.

**NOTE:**

*Assemble Editing is also possible using your VCR as the playback deck.*

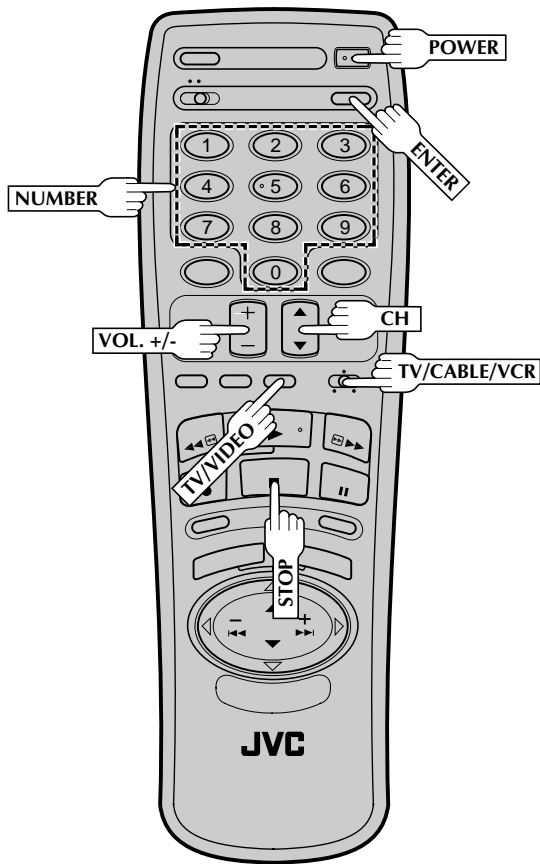

## TV Multi-Brand Remote Control

In addition to controlling several functions on JVC remote control TVs, the VCR's remote control can control these functions on the TV brands listed below.

Before you start . . .

- Turn the TV's power on using its remote control.
- Set the remote control's TV/CABLE/VCR switch to TV.

### 1 SET TV BRAND CODE

Refer to the chart below. While holding down **POWER**, enter your TV's brand code using the **NUMBER** keys, then press **STOP**.

- Once you have set the remote control to operate the TV, you don't have to repeat this step until you replace your remote control's batteries.
- PANASONIC has two codes. If the TV does not function with one code, try entering the other.

### 2 TRY OPERATING TV

Press **POWER** on the remote to turn off the TV's power. If it goes off, try other operations.

- The **POWER**, **TV/VIDEO**, **CH**▲▼, **VOL +/-** and **NUMBER** keys on the remote can all be used to operate the TV. \*For some brands of TV, you must press **ENTER** after having pressed the **NUMBER** keys.
- To return the remote to VCR control, set the **TV/CABLE/VCR** switch to **VCR**.

### NOTE:

Depending on the kind of TV, there may be cases where some or all functions cannot be operated using the remote control.

TV BRAND NAME	BRAND CODE
JVC	01
MAGNAVOX	02
MITSUBISHI	03
PANASONIC 1	04
RCA	05
SHARP	06
SONY	07
TOSHIBA	08
ZENITH	09
HITACHI	10
PANASONIC 2	11
SAMSUNG	12
SANYO/SEARS	13

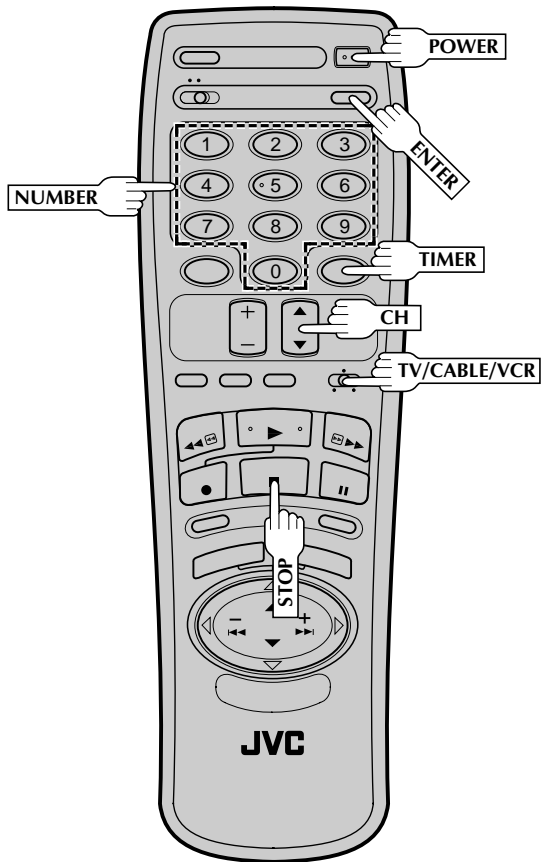

## Cable Box Multi-Brand Remote Control

The VCR's remote control can control functions on the cable boxes listed below.

Some cable box brands have more than one code. If the cable box will not function with one code, try entering another.

Before you start . . .

- Turn the cable box's power on using its remote control.
- Set the TV/CABLE/VCR switch on your VCR's remote control to CABLE.

### SET CABLE BOX BRAND CODE

1

Refer to the chart below. While holding down **POWER**, enter your cable box's brand code using the **NUMBER** keys, then press **STOP**.

- Once you have set the remote control to operate the cable box you don't have to repeat this step until you replace the remote control's batteries.

### TRY OPERATING CABLE BOX

2

Press **POWER** on the remote to turn off the cable box's power. If it goes off, try other operations.

- The **POWER**, **CH▲▼** and **NUMBER** keys on the remote can all be used to operate the cable box. \*For some brands of cable box you must press **ENTER** after having pressed the **NUMBER** keys.
- To return the remote to VCR operation, set its **TV/CABLE/VCR** switch to **VCR**.

## Child Lock

This feature allows you to prevent the operation of the VCR.

- 1 Turn the VCR's power on.
- 2 Press and hold **POWER** on the remote control until the Child Lock indicator ("L") appears on the front display panel.

\* To cancel Child Lock, press **POWER** on the remote to turn the VCR on. During timer recording, pressing **TIMER** also cancels Child Lock.

### NOTES:

- When *Child Lock* is engaged, make sure to keep the remote control out of the reach of children.
- *Timer recording* can be performed while *Child Lock* is engaged. The feature remains in effect after the recording is finished.

## NOTE:

Depending on the kind of cable box, there may be cases where some or all functions cannot be operated using the remote control.

CABLE BOX BRAND NAME	BRAND CODE
CURTIS	09, 10
GEMINI	08
GENERAL INSTRUMENTS	01, 02, 03, 04, 05, 06, 07, 08
HAMLIN	15, 16, 17, 18
JERROLD	01, 02, 03, 04, 05, 06, 07, 08
OAK	19, 20, 21
PANASONIC	24, 25, 26
PIONEER	13, 14
RCA	24, 25, 26
REGAL	15, 16, 17, 18
SUMSUNG	08, 13
SCIENTIFIC ATLANTA	09, 10
SIGMA	19, 20, 21
SL MARX	08, 13
SPRUCER	24, 25, 26
TELEVIEW	08, 13
TOCOM	22, 23
VIDEOWAY	11, 12
ZENITH	11, 12

Before requesting service for a problem, use this chart and see if you can repair the trouble yourself. Small problems are often easily corrected, and this can save you the trouble of sending your VCR off for repair.



<b>POWER</b>		
<b>SYMPTOM</b>	<b>POSSIBLE CAUSE</b>	<b>CORRECTIVE ACTION</b>
1. The power won't come on.	<ul style="list-style-type: none"> <li>• The power cord is disconnected.</li> </ul>	Connect the power cord.
2. The clock works, but the VCR's power won't come on.	<ul style="list-style-type: none"> <li>• The <b>TIMER</b> mode is engaged with Auto Timer set to "OFF" (☞ pg. 32).</li> </ul>	Press <b>TIMER</b> to disengage.
3. The remote control won't function.	<ul style="list-style-type: none"> <li>• The batteries are discharged.</li> <li>• The <b>A/B CODE</b> switch is in the wrong position.</li> <li>• The <b>TV/CABLE/VCR</b> switch is in the wrong position.</li> </ul>	Replace the dead batteries with new ones. Re-perform the A/B Code setting (☞ pg. 33). Set the switch to the position corresponding with the unit you want to operate.
<b>TAPE TRANSPORT</b>		
<b>SYMPTOM</b>	<b>POSSIBLE CAUSE</b>	<b>CORRECTIVE ACTION</b>
1. The cassette gets stuck partway during loading, and is ejected.	<ul style="list-style-type: none"> <li>• The cassette was inserted incorrectly.</li> </ul>	Make sure the window side is up, the rear label side is facing you and the arrow on the front of the cassette is pointing towards the VCR. Then insert the cassette
2. The tape stops during rewind or fast forward.	<ul style="list-style-type: none"> <li>• The Counter Memory indicator ("M") is lit on the front display panel.</li> </ul>	Press <b>C.MEMORY</b> to disengage the Counter Memory mode and extinguish the indicator.
<b>PLAYBACK</b>		
<b>SYMPTOM</b>	<b>POSSIBLE CAUSE</b>	<b>CORRECTIVE ACTION</b>
1. The tape is running but the picture won't appear.	<ul style="list-style-type: none"> <li>• If you're using the RF OUT connection (☞ pg. 6), the channel selector on the TV is set incorrectly.</li> <li>• If you're using the AV connection (☞ pg. 6), the TV receiver is set to the wrong mode.</li> </ul>	Set the channel selector to channel 3 or 4.  Set the TV receiver to its AV mode.
2. Noise appears during visual search.	<ul style="list-style-type: none"> <li>• This is normal.</li> </ul>	
3. Breaks are noticeable in Hi-Fi soundtrack.	<ul style="list-style-type: none"> <li>• Automatic tracking is engaged.</li> </ul>	Engage and adjust tracking manually (☞ pg. 17).
4. The playback picture is blurred or interrupted, even though TV broadcasts are clear.	<ul style="list-style-type: none"> <li>• The video heads may be dirty.</li> </ul>	The heads must be cleaned. Consult your JVC dealer (☞ pg. 46).
5. The Hi-Fi soundtrack cannot be heard.	<ul style="list-style-type: none"> <li>• The <b>AUDIO MONITOR</b> option at the Function Set screen was set incorrectly.</li> </ul>	Set <b>AUDIO MONITOR</b> to "HI-FI" (☞ pg. 18).
<b>RECORDING</b>		
<b>SYMPTOM</b>	<b>POSSIBLE CAUSE</b>	<b>CORRECTIVE ACTION</b>
1. Recording won't start.	<ul style="list-style-type: none"> <li>• There's no cassette loaded.</li> <li>• The loaded cassette has had its record safety tab removed.</li> </ul>	Insert a cassette. Remove the cassette and cover the hole with adhesive tape, or load a cassette on which the record safety tab is intact.

CONTINUED ON NEXT PAGE.



2. TV broadcasts won't record properly.	<ul style="list-style-type: none"> <li>• The VCR has been set to its AUX mode by mistake.</li> </ul>	Set the VCR to the appropriate channel.
3. Tape-to-tape editing won't work.	<ul style="list-style-type: none"> <li>• The VCRs or the camcorder and the VCR have been incorrectly connected.</li> <li>• The power to one or more of the units has not been turned on.</li> <li>• The recorder's input mode has been set incorrectly.</li> </ul>	Refer to the directions and the illustration under "Edit To And From Another VCR" (☞ pg. 33) or "Edit From A Camcorder" (☞ pg. 34) and properly connect the units. Make sure the power to all units is on. Set the recorder's input mode to AUX and select "FRONT" or "REAR" at the Aux Input Screen (☞ pg. 35).

**TIMER RECORDING**

SYMPTOM	POSSIBLE CAUSE	CORRECTIVE ACTION
1. Timer recording won't work.	<ul style="list-style-type: none"> <li>• The clock and/or the timer have been set incorrectly.</li> <li>• The timer is not engaged.</li> <li>• The VCR has not been set up properly.</li> </ul>	Check or re-perform the clock/timer settings to ensure correctness. Press <b>TIMER</b> and check to make sure that <b>TIMER</b> appears on the front display panel. Re-perform the clock set-up procedures (☞ pg. 7).
2. On-screen timer programming won't work.	<ul style="list-style-type: none"> <li>• Timer recording is in progress.</li> </ul>	Timer programming can't be performed when timer recording is in progress. Wait until it finishes.
3. <b>TIMER</b> and  on the front display panel won't stop blinking.	<ul style="list-style-type: none"> <li>• The timer is engaged but there's no cassette loaded.</li> </ul>	Load a cassette with the record safety tab intact, or with the hole covered with adhesive tape.
4. The cassette is automatically ejected, and <b>TIMER</b> and  on the front display panel won't stop blinking.	<ul style="list-style-type: none"> <li>• The loaded cassette has had its record safety tab removed.</li> </ul>	Remove the cassette and cover its hole with adhesive tape, or replace it with a cassette on which the safety tab is intact.
5. <b>TIMER</b> blinks for 10 seconds and the timer mode is disengaged.	<ul style="list-style-type: none"> <li>• <b>TIMER</b> has been pressed when there are no programs in memory, or the timer record program information has not been programmed correctly.</li> </ul>	Check the programmed data and re-program as necessary, then press <b>TIMER</b> again.
6. The cassette is automatically ejected, the power shuts off and <b>TIMER</b> and  won't stop blinking.	<ul style="list-style-type: none"> <li>• The end of tape was reached during timer recording.</li> </ul>	The program may not have been recorded in its entirety. Next time make sure you have enough time on the tape to record the entire program.

**OTHER PROBLEMS**

SYMPTOM	POSSIBLE CAUSE	CORRECTIVE ACTION
1. When scanning channels, some of them are skipped over.	<ul style="list-style-type: none"> <li>• Those channels have been preset to be skipped.</li> </ul>	If you need the skipped channels, restore them (☞ pg. 13).
2. The channel can't be changed.	<ul style="list-style-type: none"> <li>• Recording is in progress.</li> </ul>	Press <b>PAUSE</b> to pause the recording, change channels, then press <b>PLAY</b> to resume recording.
3. The remote control won't operate my TV.	<ul style="list-style-type: none"> <li>• The <b>TV/CABLE/VCR</b> switch is set to a position other than TV.</li> </ul>	Set the switch to TV.
4. The remote control won't operate my cable box.	<ul style="list-style-type: none"> <li>• The <b>TV/CABLE/VCR</b> switch is set to a position other than CABLE.</li> </ul>	Set the switch to CABLE.
5. Even though Auto or Semi-Auto clock setting has been selected, the clock is incorrect.	<ul style="list-style-type: none"> <li>• The clock setting data received from the Host Channel is incorrect.</li> </ul>	Select a different Host Channel during the Semi-Auto setting procedure (☞ pg. 9), or perform the Manual setting procedure (☞ pg. 10).





## QUESTIONS AND ANSWERS

### PLAYBACK

**Q. What happens if the end of the tape is reached during playback or search?**

A. The tape is automatically rewound to the beginning.

**Q. Can the VCR indefinitely remain in the still mode?**

A. No. It stops automatically after 5 minutes to protect the heads.

**Q. During search, slow, still and frame-by-frame playback, I can't hear any audio. What's the problem?**

A. This is normal.

**Q. During search, still and frame-by-frame playback, the picture is intermittent. What's the cause?**

A. Picture loss occurs when these types of playback are attempted with a tape recorded in LP mode. Pressing **PLAY** to return to normal playback will restore the picture.

**Q. When returning from multi-speed search to normal playback, the picture is disturbed. Should I be concerned about this?**

A. No, it is normal.

**Q. Noise bars appear during multi-speed search. What's the problem?**

A. This is normal.

**Q. Other than preventing further recording, what effect does removing the safety tab have?**

A. It disables marking of index codes.

**Q. Sometimes, during Index Search, the VCR can't find the program I want to see. Why not?**

A. There may be index codes too close together.

### RECORDING

**Q. When I pause and then resume a recording, the end of the recording before the pause is overlapped by the new recording. Why does this happen?**

A. This is normal. It reduces distortion at the pause and resume points.

**Q. Can the VCR indefinitely remain in the Record-Pause mode?**

A. No. The VCR automatically goes to its Stop mode after 5 minutes to protect the heads. In IT Record-pause mode the VCR shuts off automatically after 5 minutes.

**Q. What happens if the tape runs out during recording?**

A. The VCR automatically rewinds it to the beginning.

### TIMER RECORDING

**Q. REC and TIMER remain lit on the front display panel. Is there a problem?**

A. No. This is a normal condition for a timer recording in progress.

**Q. Can I program the timer while I'm watching a tape or a TV broadcast?**

A. You won't see the picture as it is replaced by the on-screen menu, but the audio from the program or tape you're viewing is present.

#### ATTENTION:

This recorder contains microcomputers. External electronic noise or interference could cause malfunctioning. In such cases, switch the power off and unplug the power cord. Then plug it in again and switch power on. Take out the cassette. After checking the cassette, operate the unit as usual.

**GENERAL**

Power requirement	: AC 120 V $\sim$ , 60 Hz
Power consumption	: 21 W
Temperature	
Operating	: 5°C to 40°C (41°F to 104°F)
Storage	: -20°C to 60°C (-4°F to 140°F)
Operating position	: Horizontal only
Dimensions (W x H x D)	: 360 x 94 x 276 mm (14-3/16" x 3-3/4" x 10-7/8")
Weight	: 3.4 kg (7.5 lbs)
Format	: VHS NTSC standard
Maximum recording time	
SP	: 210 min. with ST-210 video cassette
EP	: 630 min. with ST-210 video cassette

**VIDEO/AUDIO**

Signal system	: NTSC-type color signal and EIA monochrome signal, 525 lines/60 fields
Recording/ Playback system	: DA-4 (Double Azimuth) head helical scan system
Signal-to-noise ratio	: 45 dB
Horizontal resolution	: 240 lines
Frequency range	
Normal audio	: 70 Hz to 10,000 Hz
Hi-Fi audio	: 20 Hz to 20,000 Hz
Input/Output	: RCA connectors (IN x 2, OUT x 1)

**TUNER**

Tuning system	: Frequency-synthesized tuner
Channel coverage	
VHF	: Channels 2-13
UHF	: Channels 14-69
CATV	: 113 Channels
RF output	: Channel 3 or 4 (switchable; preset to Channel 3 when shipped) 75 ohms, unbalanced

**TIMER**

Clock reference	: Quartz
Program capacity	: 1-year programmable timer/ 8 programs
Memory backup time	: Approx. 10 min.

**ACCESSORIES**

Provided accessories	: RF cable (F-type), Infrared remote control unit, "AA" battery x 2
----------------------	---

*Specifications shown are for SP mode unless otherwise specified. E. & O.E. Design and specifications subject to change without notice.*



**List Of Terms**

This guide serves as a quick way to locate frequently used terms and on-screen display names. The first page on which the term appears is listed. Most terms appear more than once in the instruction manual.

**A**

A/B Code .....	33
Active Video Calibration .....	24
Add Channel .....	13
AFC .....	13
Audio Monitor .....	18
Auto Channel Setting .....	12
Auto Clock .....	8
Auto Clock Setting .....	8
Auto Daylight Saving Time .....	9
Auto Timer .....	32
Automatic Tracking .....	17
Aux Input .....	35
AV Compu Link Playback .....	22
AV Connection .....	6

**B**

Band .....	11
------------	----

**C**

Cancel Program .....	31
Cassette Adapter.....	7
Check Program .....	31
Child Lock .....	38
Connection to TV .....	6
Contents .....	5
Counter Memory .....	21
Counter Reset.....	21

**D**

Delete Channel .....	13
----------------------	----

**E**

Editing.....	33
--------------	----

**F**

Fast Motion Playback .....	16
Frame-by-Frame Playback .....	16
Function Setting .....	18

**H**

Host Channel Selection .....	9
------------------------------	---

**I**

Index Search .....	20
Insert Cassette .....	14
Instant ReView .....	21
ITR (Instant Timer Recording) .....	29

**L**

Language Selection .....	7
--------------------------	---

**M**

Main Menu .....	7
Manual Channel Setting .....	13
Manual Clock Setting .....	10
Manual Tracking .....	17
MBR (Multi-Brand Remote) Code Setting .....	37

**N**

Next-Function Memory .....	22
----------------------------	----

**O**

On-Screen Display .....	19
Override Auto Clock Setting .....	8

**P**

PBS Channel .....	7
Playback .....	14
Program Setting .....	29

**R**

Record Safety Tab .....	15
Recording .....	15
Repeat Playback .....	20
Reverse Motion Playback .....	16
Reverse Playback .....	16
Reverse Slow Motion Playback .....	16
RF Connection .....	6

**S**

SAP (Second Audio Program) .....	28
Second Audio .....	28
Semi-Auto Clock Setting.....	9
Shuttle Plus .....	16
Skip Search .....	20
Slow Motion Playback .....	16
Specifications .....	42
Still Playback .....	16
Superimpose .....	19

**T**

Tape Position Indicator .....	22
Tape Speed Setting .....	15
Time Zone Selection .....	9
Timer Programming.....	29
Timer Recording.....	29
Tuner Setting .....	11

## FRONT VIEW

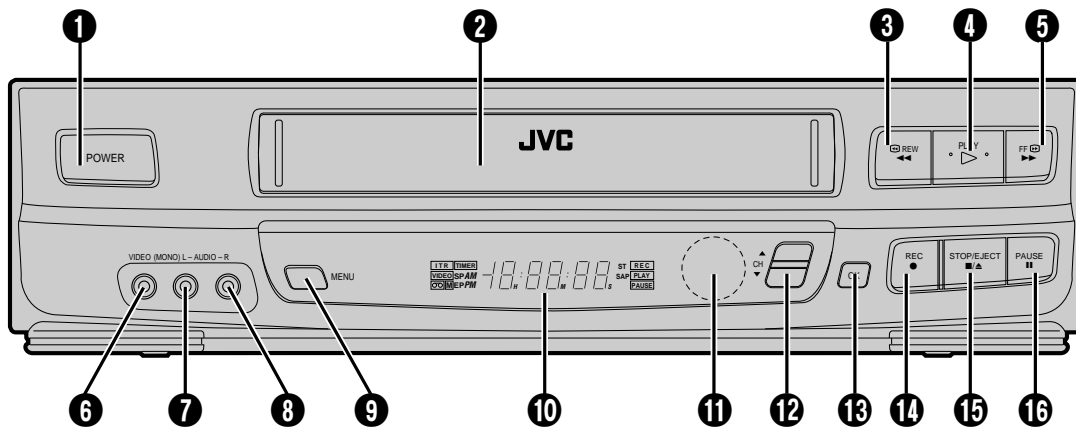

- 1 Power ON/OFF Button (☞ pg. 7)
- 2 Cassette Loading Slot
- 3 Rewind Button (☞ pg. 14)
- 4 Play Button (☞ pg. 14)
- 5 Fast-Forward Button (☞ pg. 14)
- 6 Video Input Connector (☞ pg. 34)
- 7 Mono Audio Input Connector (☞ pg. 34)
- 8 Audio Input Connector [R] (☞ pg. 34)
- 9 Menu Button (☞ pg. 7)
- 10 Front Display Panel (☞ pg. 45)
- 11 Remote Control Sensor
- 12 Channel ▲▼ Buttons (☞ pg. 7)
- 13 OK Button (☞ pg. 7)
- 14 Record Button (☞ pg. 15)
- 15 Stop/Eject Button (☞ pg. 14)
- 16 Pause Button (☞ pg. 15)

## REAR VIEW

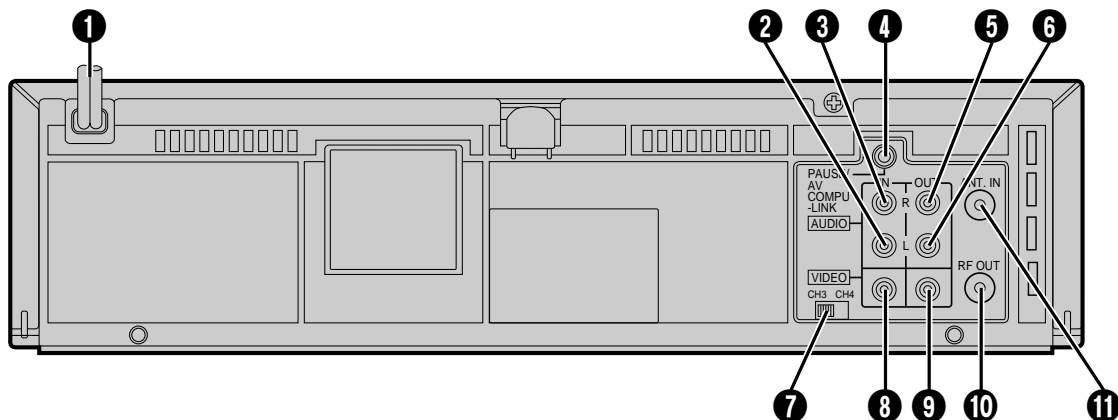

- 1 Power Cord (☞ pg. 6)
- 2 Mono Audio Input Connector (☞ pg. 33)
- 3 Audio Input Connector [R] (☞ pg. 33)
- 4 Remote PAUSE Connector (☞ pg. 34)
- 5 Hi-Fi Audio Output Connector [R] (☞ pg. 6)
- 6 Hi-Fi Audio Output Connector [L] (☞ pg. 6)
- 7 Channel 3/4 Switch (☞ pg. 6)
- 8 Video Input Connector (☞ pg. 33)
- 9 Video Output Connector (☞ pg. 6)
- 10 RF OUT Connector (☞ pg. 6)
- 11 ANT. IN Connector (☞ pg. 6)

## FRONT DISPLAY PANEL

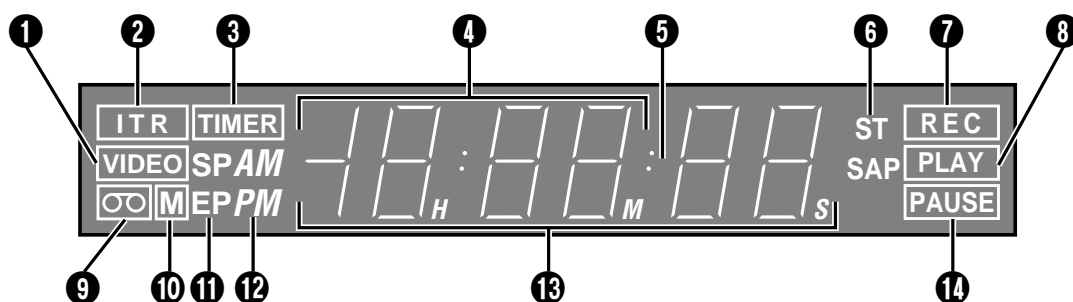

- 1 Video Mode Indicator (☞ pg. 7)
- 2 Instant Timer Recording Indicator (☞ pg. 29)
- 3 Timer Mode Indicator (☞ pg. 30)
- 4 Clock Display (☞ pg. 7)
- 5 Counter Display (☞ pg. 21)
- 6 Multichannel TV Sound Indicators (☞ pg. 28)
- 7 Recording Mode Indicator (☞ pg. 15)
- 8 Play Mode Indicator (☞ pg. 14)
- 9 "Cassette Loaded" Mark
- 10 Counter Memory Mark (☞ pg. 21)
- 11 Tape Speed Indicators (☞ pg. 15)
- 12 AM/PM Indicators (☞ pg. 7)
- 13 Channel Display ["AU" for AUX mode] (☞ pg. 34)
- 14 Pause Mode Indicator (☞ pg. 15)

## REMOTE CONTROL (Provided)

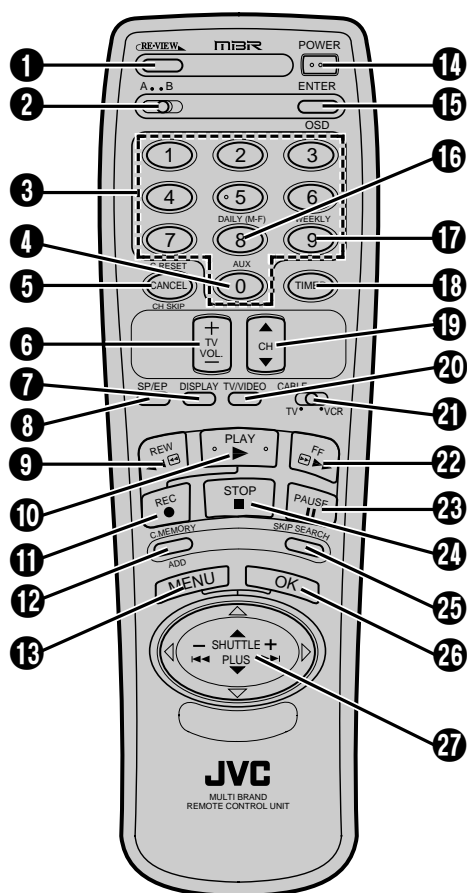

- 1 Instant REVIEW Button (☞ pg. 21)
- 2 A/B Code Select Switch (☞ pg. 33)
- 3 NUMBER Buttons (☞ pg. 9)
- 4 "AUX" Mode Select Button (☞ pg. 34)
- 5 CANCEL Button (☞ pg. 31)  
Counter [C.] RESET (☞ pg. 21)  
Channel [CH.] SKIP Button (☞ pg. 13)
- 6 Volume [VOL] +/- Buttons (☞ pg. 37)
- 7 DISPLAY Button (☞ pg. 21)
- 8 Recording Speed [SP/EP] Button (☞ pg. 15)
- 9 Rewind [REW] Button (☞ pg. 14)
- 10 PLAY Button (☞ pg. 14)
- 11 Record [REC] Button (☞ pg. 15)
- 12 Counter [C.] MEMORY Button (☞ pg. 21)  
ADD Button (☞ pg. 13)
- 13 MENU Button (☞ pg. 7)
- 14 POWER ON/OFF Button (☞ pg. 7)
- 15 ENTER Button (☞ pg. 15)  
On-Screen Display [OSD] Button (☞ pg. 19)
- 16 DAILY Timer Recording Button (☞ pg. 30)
- 17 WEEKLY Timer Recording Button (☞ pg. 30)
- 18 TIMER Button (☞ pg. 30)
- 19 Channel [CH] ▲▼ Buttons (☞ pg. 7)
- 20 TV/VIDEO Button (☞ pg. 7)
- 21 TV/CABLE/VCR Switch (☞ pg. 37)
- 22 Fast-Forward [FF] Button (☞ pg. 14)
- 23 PAUSE Button (☞ pg. 15)
- 24 STOP Button (☞ pg. 14)
- 25 SKIP SEARCH Button (☞ pg. 20)
- 26 OK Button (☞ pg. 7)
- 27 SHUTTLE PLUS Button (☞ pg. 7)

## HOW TO LOCATE YOUR JVC SERVICE CENTER

**TOLL FREE: 1-800-252-5722**

**Dear customer:**

*In order to receive the most satisfaction from your purchase, read the instruction booklet before operating the unit. In the event that repair is necessary, or for the address nearest your location, please refer to the factory service center list below or within the Continental United States, call 1-800-252-5722 for your authorized servicer. Remember to retain your Bill of Sale for Warranty Service.*

— JVC

### JVC SERVICE & ENGINEERING COMPANY OF AMERICA DIVISION OF US JVC CORP.

#### FACTORY SERVICE CENTER LOCATIONS

107 Little Falls Road  
Fairfield, NJ 07004-2105  
(201) 808-9279

1500 Lakes Parkway  
Lawrenceville, GA 30243-5357  
(770) 339-2522

705 Enterprise Street  
Aurora, IL 60504-8149  
(708) 851-7855

5665 Corporate Avenue  
Cypress, CA 90630-0024  
(714) 229-8011

10700 Hammerly, Suite 110  
Houston, TX 77043-2310  
(713) 935-9331

2969 Mapunapuna Place  
Honolulu, HI 96819-2040  
(808) 833-5828

230 Eliot Street  
Ashland, MA 01721-2377  
(508) 881-5923

14505 Commerce Way  
Miami Lakes, FL 33016-1512  
(305) 362-6252

890 Dubuque Avenue  
South San Francisco, CA 94080-1804  
(415) 871-2666

*Sophisticated electronic products may require occasional service. Just as quality is a keyword in the engineering and production of the wide array of JVC products, service is the key to maintaining the high level performance for which JVC is world famous. The JVC service and engineering organization stands behind our products.*

NATIONAL HEADQUARTERS  
JVC SERVICE & ENGINEERING COMPANY OF AMERICA  
DIVISION OF US JVC CORP.  
107 Little Falls Road  
Fairfield, NJ 07004-2105

#### **If you ship the product...**

*Pack your JVC unit in the original carton or one of equivalent size and strength. Enclose, with the unit, a letter stating the problem or symptom that exists and also a copy of the receipt or bill of sale you received when you purchased your JVC unit. Print your home return address on the outside and the inside of the carton. Send to the appropriate JVC Factory Service Center as listed above.*

#### **Don't service it yourself.**

##### **CAUTION**

*To prevent electrical shock, do not open the cabinet. No user serviceable parts inside.  
Refer servicing to qualified service personnel.*

#### **ACCESSORIES**

*To purchase accessories for your JVC product, you may contact your local JVC Dealer.  
Or from the 48 Continental United States call toll free:  
1-800-882-2345.*

LIMITED WARRANTY

CONSUMER VIDEO 1-90

JVC COMPANY OF AMERICA warrants this product and all parts thereof, except as set forth below ONLY TO THE ORIGINAL PURCHASER AT RETAIL to be FREE FROM DEFECTIVE MATERIALS AND WORKMANSHIP from the date of original retail purchase for the period as shown below. ("The Warranty Period")

PARTS	1 YR	LABOR	90 DAYS
-------	------	-------	---------

THIS LIMITED WARRANTY IS VALID ONLY IN THE FIFTY (50) UNITED STATES, THE DISTRICT OF COLUMBIA AND IN COMMONWEALTH OF PUERTO RICO.

WHAT WE WILL DO:

If this product is found to be defective, JVC will repair or replace defective parts at no charge to the original owner. Such repair and replacement services shall be rendered by JVC during normal business hours at JVC authorized service centers. Parts used for replacement are warranted only for the remainder of the Warranty Period. All products and parts thereof may be brought to a JVC authorized service center on a carry-in basis except for Television sets having a screen size 25 inches and above which are covered on an in-home basis.

WHAT YOU MUST DO FOR WARRANTY SERVICE:

Return your product to a JVC authorized service center with a copy of your bill of sale. For your nearest JVC authorized service center, please call toll free: (800) 252-5722.

If service is not available locally, box the product carefully, preferably in the original carton, and ship, insured, with a copy of your bill of sale plus a letter of explanation of the problem to the nearest JVC Factory Service Center, the name and location of which will be given to you by the toll-free number.

If you have any questions concerning your JVC Product, please contact our Customer Relations Department.

WHAT IS NOT COVERED:

This limited warranty provided by JVC does not cover:

1. Products which have been subject to abuse, accident, alteration, modification, tampering, negligence, misuse, faulty installation, lack of reasonable care, or if repaired or serviced by anyone other than a service facility authorized by JVC to render such service, or if affixed to any attachment not provided with the products, or if the model or serial number has been altered, tampered with, defaced or removed;
2. Initial installation and installation and removal for repair;
3. Operational adjustments covered in the Owner's Manual, normal maintenance, video and audio head cleaning;
4. Damage that occurs in shipment, due to act of God, and cosmetic damage;
5. Signal reception problems and failures due to line power surge;
6. Video Pick-up Tubes/CCD Image Sensor, Cartridge, Stylus (Needle) are covered for 90 days from the date of purchase;
7. Accessories;
8. Batteries (except that Rechargeable Batteries are covered for 90 days from the date of purchase); from the date of purchase);

There are no other express warranties except as listed above.

THE DURATION OF ANY IMPLIED WARRANTIES INCLUDING THE IMPLIED WARRANTY OF MERCHANTABILITY, IS LIMITED TO THE DURATION OF THE EXPRESS WARRANTY HEREIN.

JVC SHALL NOT BE LIABLE FOR THE LOSS OF USE OF THE PRODUCT, INCONVENIENCE, LOSS OR ANY OTHER DAMAGES, WHETHER DIRECT, INCIDENTAL OR CONSEQUENTIAL (INCLUDING, WITHOUT LIMITATION, DAMAGE TO TAPES, RECORDS OR DISCS) RESULTING FROM THE USE OF THIS PRODUCT, OR ARISING OUT OF ANY BREACH OF THIS WARRANTY. ALL EXPRESS AND IMPLIED WARRANTIES, INCLUDING THE WARRANTIES OF MERCHANTABILITY AND FITNESS FOR PARTICULAR PURPOSE, ARE LIMITED TO THE WARRANTY PERIOD SET FORTH ABOVE.

Some states do not allow the exclusion of incidental or consequential damages or limitations on how long an implied warranty lasts, so these limitations or exclusions may not apply to you. This warranty gives you specific legal rights and you may also have other rights which vary from state to state.

JVC COMPANY OF AMERICA  
DIVISION OF US JVC CORP.

41 Slater Drive  
Elmwood Park, New Jersey 07407

REFURBISHED PRODUCTS CARRY A SEPARATE WARRANTY, THIS WARRANTY DOES NOT APPLY. FOR DETAILS OF REFURBISHED PRODUCT WARRANTY, PLEASE REFER TO THE REFURBISHED PRODUCT WARRANTY INFORMATION PACKAGED WITH EACH REFURBISHED PRODUCT.

For customer use:

Enter below the Model No. and Serial No. which is located either on the rear, bottom or side of the cabinet. Retain this information for future reference.

Model No.: \_\_\_\_\_

Serial No.: \_\_\_\_\_

Purchase date: \_\_\_\_\_

Name of dealer: \_\_\_\_\_

HR-J633U

**JVC**

**JVC COMPANY OF AMERICA**  
DIVISION OF US JVC CORP.  
41 Slater Drive, Elmwood Park, N.J. 07407

COPYRIGHT © 1995 VICTOR COMPANY OF JAPAN, LTD.

 Printed in Malaysia  
1295HOV\*UN\*PJ